

WAGO-I/O-SYSTEM 750

Manual



750-438

2DI NAMUR Ex i

2-Channel Digital Input Module NAMUR, Ex i, Proximity sensor acc. to EN 60947 5-6

1.4.0
HW Version 05

© 2017 WAGO Kontakttechnik GmbH & Co. KG
All rights reserved.

WAGO Kontakttechnik GmbH & Co. KG

Hansastraße 27
D-32423 Minden

Phone: +49 (0) 571/8 87 – 0
Fax: +49 (0) 571/8 87 – 1 69

E-Mail: info@wago.com

Web: <http://www.wago.com>

Technical Support

Phone: +49 (0) 571/8 87 – 5 55
Fax: +49 (0) 571/8 87 – 85 55

E-Mail: support@wago.com

Every conceivable measure has been taken to ensure the accuracy and completeness of this documentation. However, as errors can never be fully excluded, we always appreciate any information or suggestions for improving the documentation.

E-Mail: documentation@wago.com

We wish to point out that the software and hardware terms as well as the trademarks of companies used and/or mentioned in the present manual are generally protected by trademark or patent.

WAGO is a registered trademark of WAGO Verwaltungsgesellschaft mbH.

Table of Contents

1	Notes about this Documentation.....	5
1.1	Validity of this Documentation.....	5
1.2	Copyright.....	5
1.3	Symbols.....	6
1.4	Number Notation.....	8
1.5	Font Conventions.....	8
2	Important Notes	9
2.1	Legal Bases	9
2.1.1	Subject to Changes	9
2.1.2	Personnel Qualifications.....	9
2.1.3	Use of the WAGO-I/O-SYSTEM 750 in Compliance with Underlying Provisions.....	9
2.1.4	Technical Condition of Specified Devices.....	10
2.2	Safety Advice (Precautions).....	11
3	Device Description	13
3.1	View	14
3.2	Connectors.....	15
3.2.1	Data Contacts/Internal Bus.....	15
3.2.2	Power Jumper Contacts/Field Supply	16
3.2.3	CAGE CLAMP® Connectors	17
3.3	Display Elements	17
3.4	Operating Elements.....	18
3.5	Schematic Diagram	19
3.6	Technical Data	20
3.6.1	Device Data	20
3.6.2	Supply.....	20
3.6.3	Communication	20
3.6.4	Inputs	20
3.6.5	Explosion Protection	21
3.6.6	Connection Type	21
3.6.7	Climatic Environmental Conditions.....	22
3.7	Approvals	23
3.8	Standards and Guidelines.....	24
4	Process Image	27
5	Mounting.....	28
5.1	Mounting Sequence.....	28
5.2	Inserting and Removing Devices	29
5.2.1	Inserting the I/O Module	29
5.2.2	Removing the I/O Module.....	30
6	Connect Devices	31
6.1	Connecting a Conductor to the CAGE CLAMP®	31
6.2	Power Supply Concept.....	32
6.2.1	Power Supply Concept in Marine Applications.....	34
6.3	Connection Example	36

7	Use in Hazardous Environments	37
7.1	Marking Configuration Examples	38
7.1.1	Marking for Europe According to ATEX and IECEx	38
7.1.2	Marking for America (NEC) and Canada (CEC)	41
7.2	Installation Regulations	45
7.2.1	Special Notes Regarding Explosion Protection	45
7.2.2	Special Notes Regarding ANSI/ISA Ex	47
8	Appendix	48
8.1	Rated Surge Voltage	48
	List of Figures	49
	List of Tables	50

1 Notes about this Documentation

Note



Always retain this documentation!

This documentation is part of the product. Therefore, retain the documentation during the entire service life of the product. Pass on the documentation to any subsequent user. In addition, ensure that any supplement to this documentation is included, if necessary.

1.1 Validity of this Documentation

This documentation is only applicable to the I/O module 750-438 (2DI NAMUR Ex i).

The I/O module 750-438 shall only be installed and operated according to the instructions in this manual and in the manual for the used fieldbus coupler/controller.

NOTICE

Consider power layout of the WAGO-I/O-SYSTEM 750!

In addition to these operating instructions, you will also need the manual for the used fieldbus coupler/controller, which can be downloaded at www.wago.com. There, you can obtain important information including information on electrical isolation, system power and supply specifications.

1.2 Copyright

This Manual, including all figures and illustrations, is copyright-protected. Any further use of this Manual by third parties that violate pertinent copyright provisions is prohibited. Reproduction, translation, electronic and phototechnical filing/archiving (e.g., photocopying) as well as any amendments require the written consent of WAGO Kontakttechnik GmbH & Co. KG, Minden, Germany. Non-observance will involve the right to assert damage claims.

1.3 Symbols

 **DANGER****Personal Injury!**

Indicates a high-risk, imminently hazardous situation which, if not avoided, will result in death or serious injury.

 **DANGER****Personal Injury Caused by Electric Current!**

Indicates a high-risk, imminently hazardous situation which, if not avoided, will result in death or serious injury.

 **WARNING****Personal Injury!**

Indicates a moderate-risk, potentially hazardous situation which, if not avoided, could result in death or serious injury.

 **CAUTION****Personal Injury!**

Indicates a low-risk, potentially hazardous situation which, if not avoided, may result in minor or moderate injury.

NOTICE**Damage to Property!**

Indicates a potentially hazardous situation which, if not avoided, may result in damage to property.

NOTICE**Damage to Property Caused by Electrostatic Discharge (ESD)!**

Indicates a potentially hazardous situation which, if not avoided, may result in damage to property.

Note**Important Note!**

Indicates a potential malfunction which, if not avoided, however, will not result in damage to property.



Information

Additional Information:

Refers to additional information which is not an integral part of this documentation (e.g., the Internet).

1.4 Number Notation

Table 1: Number Notation

Number Code	Example	Note
Decimal	100	Normal notation
Hexadecimal	0x64	C notation
Binary	'100' '0110.0100'	In quotation marks, nibble separated with dots (.)

1.5 Font Conventions

Table 2: Font Conventions

Font Type	Indicates
<i>italic</i>	Names of paths and data files are marked in italic-type. e.g.: <i>C:\Program Files\WAGO Software</i>
Menu	Menu items are marked in bold letters. e.g.: Save
>	A greater-than sign between two names means the selection of a menu item from a menu. e.g.: File > New
Input	Designation of input or optional fields are marked in bold letters, e.g.: Start of measurement range
“Value”	Input or selective values are marked in inverted commas. e.g.: Enter the value “4 mA” under Start of measurement range .
[Button]	Pushbuttons in dialog boxes are marked with bold letters in square brackets. e.g.: [Input]
[Key]	Keys are marked with bold letters in square brackets. e.g.: [F5]

2 Important Notes

This section includes an overall summary of the most important safety requirements and notes that are mentioned in each individual section. To protect your health and prevent damage to devices as well, it is imperative to read and carefully follow the safety guidelines.

2.1 Legal Bases

2.1.1 Subject to Changes

WAGO Kontakttechnik GmbH & Co. KG reserves the right to provide for any alterations or modifications. WAGO Kontakttechnik GmbH & Co. KG owns all rights arising from the granting of patents or from the legal protection of utility patents. Third-party products are always mentioned without any reference to patent rights. Thus, the existence of such rights cannot be excluded.

2.1.2 Personnel Qualifications

All sequences implemented on WAGO-I/O-SYSTEM 750 devices may only be carried out by electrical specialists with sufficient knowledge in automation. The specialists must be familiar with the current norms and guidelines for the devices and automated environments.

All changes to the coupler or controller should always be carried out by qualified personnel with sufficient skills in PLC programming.

2.1.3 Use of the WAGO-I/O-SYSTEM 750 in Compliance with Underlying Provisions

Fieldbus couplers, fieldbus controllers and I/O modules found in the modular WAGO-I/O-SYSTEM 750 receive digital and analog signals from sensors and transmit them to actuators or higher-level control systems. Using programmable controllers, the signals can also be (pre-) processed.

The devices have been developed for use in an environment that meets the IP20 protection class criteria. Protection against finger injury and solid impurities up to 12.5 mm diameter is assured; protection against water damage is not ensured. Unless otherwise specified, operation of the devices in wet and dusty environments is prohibited.

Operating the WAGO-I/O-SYSTEM 750 devices in home applications without further measures is only permitted if they meet the emission limits (emissions of interference) according to EN 61000-6-3. You will find the relevant information in the section “Device Description” > “Standards and Guidelines” in the manual for the used fieldbus coupler/controller.

Appropriate housing (per 2014/34/EU) is required when operating the WAGO-I/O-SYSTEM 750 in hazardous environments. Please note that a prototype test

certificate must be obtained that confirms the correct installation of the system in a housing or switch cabinet.

2.1.4 Technical Condition of Specified Devices

The devices to be supplied ex works are equipped with hardware and software configurations, which meet the individual application requirements. WAGO Kontakttechnik GmbH & Co. KG will be exempted from any liability in case of changes in hardware or software as well as to non-compliant usage of devices.

Please send your request for modified and new hardware or software configurations directly to WAGO Kontakttechnik GmbH & Co. KG.

2.2 Safety Advice (Precautions)

For installing and operating purposes of the relevant device to your system the following safety precautions shall be observed:



DANGER

Do not work on devices while energized!

All power sources to the device shall be switched off prior to performing any installation, repair or maintenance work.

DANGER

Install the device only in appropriate housings, cabinets or in electrical operation rooms!

The WAGO-I/O-SYSTEM 750 and its components are an open system. As such, install the system and its components exclusively in appropriate housings, cabinets or in electrical operation rooms. Allow access to such equipment and fixtures to authorized, qualified staff only by means of specific keys or tools.

NOTICE

Replace defective or damaged devices!

Replace defective or damaged device/module (e.g., in the event of deformed contacts), since the long-term functionality of device/module involved can no longer be ensured.

NOTICE

Protect the components against materials having seeping and insulating properties!

The components are not resistant to materials having seeping and insulating properties such as: aerosols, silicones and triglycerides (found in some hand creams). If you cannot exclude that such materials will appear in the component environment, then install the components in an enclosure being resistant to the above-mentioned materials. Clean tools and materials are imperative for handling devices/modules.

NOTICE

Clean only with permitted materials!

Clean soiled contacts using oil-free compressed air or with ethyl alcohol and leather cloths.

NOTICE**Do not use any contact spray!**

Do not use any contact spray. The spray may impair contact area functionality in connection with contamination.

NOTICE**Do not reverse the polarity of connection lines!**

Avoid reverse polarity of data and power supply lines, as this may damage the devices involved.

NOTICE**Avoid electrostatic discharge!**

The devices are equipped with electronic components that may be destroyed by electrostatic discharge when touched. Please observe the safety precautions against electrostatic discharge per DIN EN 61340-5-1/-3. When handling the devices, please ensure that environmental factors (personnel, work space and packaging) are properly grounded.

3 Device Description

The digital input module 750-438 receives binary signals from sensors operating in hazardous environments of zones 0 or 1, e.g. NAMUR sensors, optocouplers, mechanical contacts or other actuating elements.

WARNING

Installation only in zone 2 or in non-hazardous environments!

The installation of the WAGO-I/O-SYSTEM 750 fieldbus couplers/controllers and I/O modules is only to be done in zone 2 or in non-hazardous environments.

The I/O module has 2 input channels, providing a direct, intrinsically safe connection to 2-wire sensors. The input signals are connected to the DI 1 or DI 2 CAGE CLAMP[®] terminals and the sensor supplies to the Uv 1 or Uv 2 CAGE CLAMP[®] terminals.

The Uv terminals supply a short-circuit proof voltage of 8.2 V to the sensors.

Note



Use shielded signal lines!

Only use shielded signal lines for analog signals and I/O modules which are equipped with shield clamps. Only then can you ensure that the accuracy and interference immunity specified for the respective I/O module can be achieved even in the presence of interference acting on the signal cable.

The assignment of the connections is described in the “Connectors” section. Connection examples are shown in section “Connect Devices” > ... > “Connection Example(s)”.

A green LED indicates the switched status of each channel.

The meaning of the LEDs is described in the “Display Elements” section.

Any configuration of the I/O module is possible within an intrinsically safe segment when configuring the fieldbus node. An arrangement in groups within the group of potentials is not necessary.

The Ex i I/O module receives the 24 V voltage supply for the field level from an upstream Ex i I/O module or from an Ex i power supply module via the power contacts used as blade contacts. It then provides this potential to subsequent I/O modules via the power contacts used as spring contacts.

The I/O module 750-438 can be used with all fieldbus couplers/controllers of the WAGO-I/O-SYSTEM 750.

The field voltage and the system voltage are electrically isolated from each other.

3.1 View

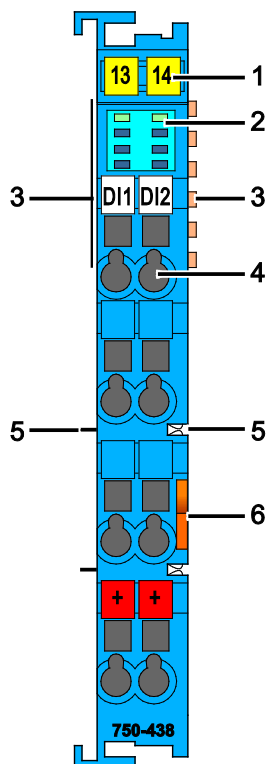

Figure 1: View

Table 3: Legend for Figure “View”

Pos.	Description	Details See Section
1	Marking possibility with Mini-WSB	---
2	Status LEDs	“Device Description” > “Display Elements”
3	Data contacts	“Device Description” > “Connectors”
4	CAGE CLAMP [®] connectors	“Device Description” > “Connectors”
5	Power jumper contacts	“Device Description” > “Connectors”
6	Release tab	“Mounting” > “Inserting and Removing Devices”

3.2 Connectors

3.2.1 Data Contacts/Internal Bus

Communication between the fieldbus coupler/controller and the I/O modules as well as the system supply of the I/O modules is carried out via the internal bus. It is comprised of 6 data contacts, which are available as self-cleaning gold spring contacts.

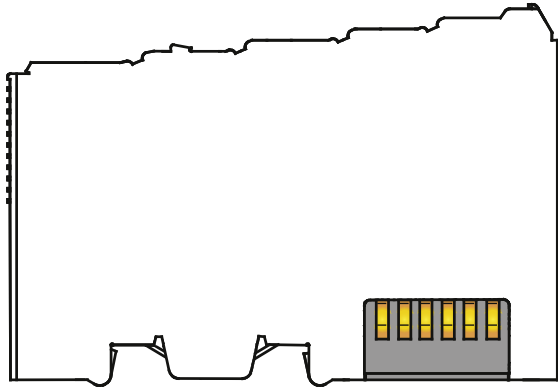

Figure 2: Data Contacts

NOTICE

Do not place the I/O modules on the gold spring contacts!

Do not place the I/O modules on the gold spring contacts in order to avoid soiling or scratching!

NOTICE



Ensure that the environment is well grounded!

The devices are equipped with electronic components that may be destroyed by electrostatic discharge. When handling the devices, ensure that the environment (persons, workplace and packing) is well grounded. Avoid touching conductive components, e.g. data contacts.

3.2.2 Power Jumper Contacts/Field Supply

⚠ CAUTION

Risk of injury due to sharp-edged blade contacts!

The blade contacts are sharp-edged. Handle the I/O module carefully to prevent injury.

The I/O module 750-438 has 2 self-cleaning power jumper contacts that supply and transmit power for the field side. The contacts on the left side of the I/O module are designed as blade contacts and those on the right side as spring contacts.

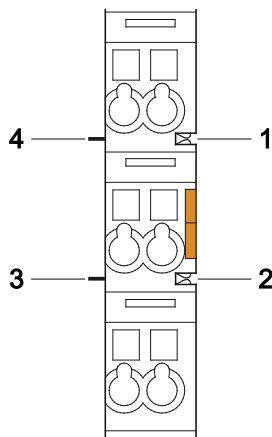

Figure 3: Power Jumper Contacts

Table 4: Legend for Figure “Power Jumper Contacts”

Contact	Type	Function
1	Spring contact	Potential transmission (U_V) for field supply
2	Spring contact	Potential transmission (0 V) for field supply
3	Blade contact	Potential feed-in (0 V) for field supply
4	Blade contact	Potential feed-in (U_V) for field supply



Note

Do not exceed maximum current via power contacts!

The maximum current available from the 750-606 or 750-625/000-001 Ex-i Supply Module is 1 A.

When configuring the system, ensure that this current is not exceeded.

If exceeded, an additional potential feed module must be used.

3.2.3 CAGE CLAMP® Connectors

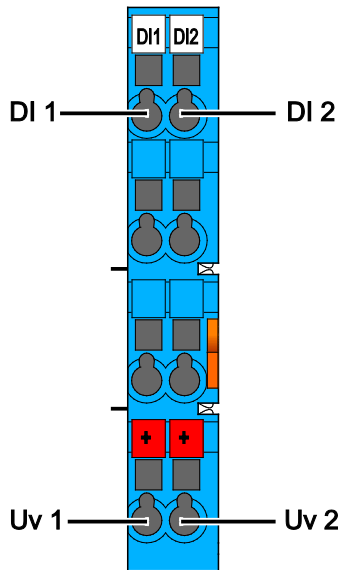

Figure 4: CAGE CLAMP® Connectors

Table 5: Legend for Figure “CAGE CLAMP® Connectors”

Channel	Designation	Connection	Function
1	DI 1	1	Signal voltage
	Uv 1	4	Sensor supply
2	DI 2	5	Signal voltage
	Uv 2	8	Sensor supply

3.3 Display Elements

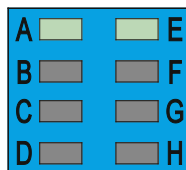

Figure 5: Display Elements

Table 6: Legend for Figure “Display Elements”

Channel	Designation	LED	Status	Function
1	Status DI 1	A	off	Input DI 1: Signal voltage (0)
			green	Input DI 1: Signal voltage (1)
2	Status DI 2	E	off	Input DI 2: Signal voltage (0)
			green	Input DI 2: Signal voltage (1)

3.4 Operating Elements

The I/O module 750-438 has no operating elements.

3.5 Schematic Diagram

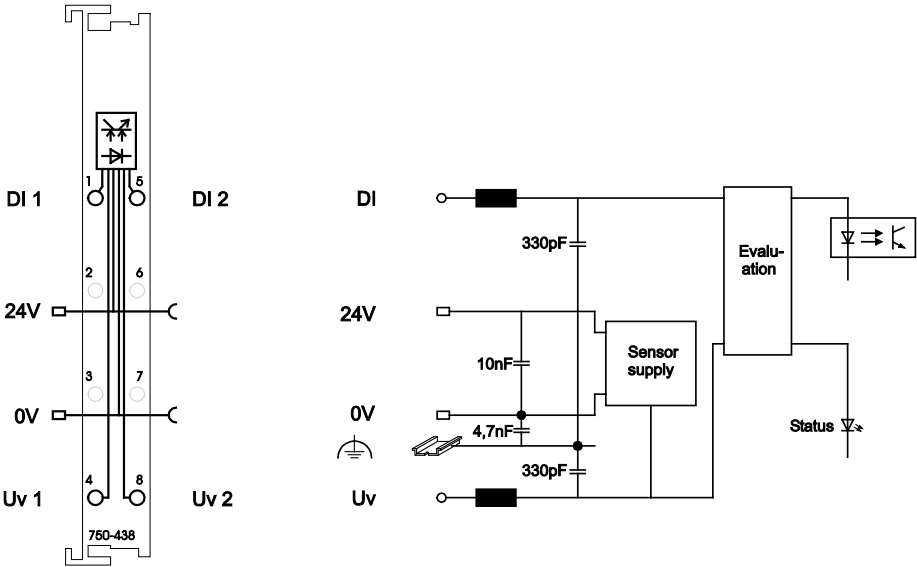

Figure 6: Schematic Diagram

3.6 Technical Data

3.6.1 Device Data

Table 7: Technical Data – Device

Wide	12 mm
Height (from upper edge of 35 DIN rail)	64 mm
Depth	100 mm
Weight	Approx. 48.5 g

3.6.2 Supply

Table 2: Technical Data – Supply

Voltage supply	Via system voltage terminal bus (5 V DC) and power contacts (24 V DC)
Current consumption $I_{typ.}$ (internal) (5 V DC)	2.5 mA
Input current $I_{typ.}$ (Field) (24 V DC)	16 mA + load
Voltage via power jumper contacts	24 V DC (Supply via Ex i-supply module $U_0 = \max. 27.3$ V)
Current via power contacts $I_{max.}$	1000 mA
Power consumption $P_{max.}$	0.4 W
Power loss P_V	0.27 W
Isolation	300 VAC system/supply

3.6.3 Communication

Table 3: Technical Data – Communication

Internal bit width (terminal bus)	2 bits input (2 bits data)
-----------------------------------	----------------------------

3.6.4 Inputs

Table 4: Technical Data – Inputs

No. of inputs	2
Signal current (0)	≤ 1.2 mA
Signal current (1)	≥ 2.1 mA
Switching hysteresis	0.2 mA
Input filter	3 ms
Input pulse duration	≥ 5 ms
Input pulse separation	≥ 3 ms
Input resistance	1 k Ω
Short-circuit current	≤ 8.2 mA
Sensor supply U_V	DC 8.2 V
Open-circuit voltage	DC 8.2 V

3.6.5 Explosion Protection

Table 8: Technical Data – Explosion Protection

Voltage supply via power jumper contacts (LK1, LK2)		$U_i = 27.3 \text{ V}$ $P_{\max} = 0.4 \text{ W}$	
Interface circuit (K-Bus)		$U_n = 5 \text{ V}$ $U_m = 253 \text{ V}$	
(Cage Clamp 1, 4 and 5, 6)		$U_0 = 12 \text{ V}$ $I_0 = 13.5 \text{ mA}$ $P_0 = 40.5 \text{ mW}$ Line characteristic: linear	
Reactance <u>without</u> consideration of the simultaneousness		L_0	C_0
	Ex ia IIC	190 mH	1.4 μF
	Ex ia IIB	600 mH	9 μF
	Ex ia IIA	1 H	36 μF
	Ex ia I	1 H	38 μF
Reactance <u>with</u> consideration of the simultaneousness		L_0	C_0
	Ex ia II C	0.05 mH	1.40 μF
		1.0 mH	0.63 μF
		10.0 mH	0.43 μF
		50.0 mH	0.33 μF
		100.0 mH	0.29 μF
	Ex ia II B	0.02 mH	9.0 μF
		1.0 mH	3.4 μF
		10.0 mH	2.2 μF
		50.0 mH	1.8 μF
		100.0 mH	1.6 μF
	Ex ia II A	0.1 mH	11 μF
		1.0 mH	5.8 μF
		5.0 mH	4.1 μF
		20.0 mH	3.2 μF
		100.0 mH	2.5 μF
	Ex ia I	0.01 mH	34 μF
		0.05 mH	17 μF
		0.2 mH	11 μF
		1.0 mH	7.3 μF
		5.0 mH	5.2 μF

3.6.6 Connection Type

Table 9: Technical Data – Field Wiring

Wire connection	CAGE CLAMP [®]
Cross section	0.08 mm ² ... 2.5 mm ² , AWG 28 ... 14
Stripped lengths	8 mm ... 9 mm / 0.33 in

Table 10: Technical Data – Power Jumper Contacts

Power jumper contacts	Blade/spring contact, self-cleaning
-----------------------	-------------------------------------

Table 11: Technical Data – Data Contacts

Data contacts	Slide contact, hard gold plated, self-cleaning
---------------	--

3.6.7 Climatic Environmental Conditions

Table 12: Technical Data – Climatic Environmental Conditions

Operating temperature range	0 °C ... 55 °C
Storage temperature range	-25 °C ... +85 °C
Relative humidity without condensation	Max. 95 %
Resistance to harmful substances	Acc. to IEC 60068-2-42 and IEC 60068-2-43
Maximum pollutant concentration at relative humidity < 75 %	SO ₂ ≤ 25 ppm H ₂ S ≤ 10 ppm
Special conditions	Ensure that additional measures for components are taken, which are used in an environment involving: <ul style="list-style-type: none"> – dust, caustic vapors or gases – ionizing radiation

3.7 Approvals

Information



More information about approvals.

Detailed references to the approvals are listed in the document “Overview Approvals **WAGO-I/O-SYSTEM 750**”, which you can find via the internet under: www.wago.com > SERVICES > DOWNLOADS > Additional documentation and information on automation products > WAGO-I/O-SYSTEM 750 > System Description.

The following approvals have been granted to 750-438 I/O modules:



Conformity Marking



UL E175199 for
use in Ordinary
Location



Korea Certification

MSIP-REM-W43-DIM750

The following Ex approvals have been granted to 750-438 I/O modules:

TÜV 12 ATEX 106032 X



I M2 (M1) Ex d [ia Ma] I Mb
II 3 (1) G Ex ec [ia Ga] IIC T4 Gc
II 3 (1) D Ex tc [ia Da] IIIC T135°C Dc



IECEX TUN 12.0039 X

Ex d [ia Ma] I Mb
Ex ec [ia Ga] IIC T4 Gc
Ex tc [ia Da] IIIC T135°C Dc



TÜV 14.1911 X

Ex d [ia Ma] I Mb
Ex nA [ia Ga] IIC T4 Gc
Ex tc [ia Da] IIIC T135°C Dc

UL E480271 for Use in Zone Classified Hazardous Locations













Cl I Zn 2 AEx nA [ia Ga] IIC T4 Gc
Cl I Zn 2 AEx nA [ia IIIC] IIC T4 Gc
Ex nA [ia Ga] IIC T4 Gc X
Ex nA [ia IIIC] IIC T4 Gc X



UL E198726 for Use in Hazardous Locations
Cl I, Div 2, Group A, B, C, D, T4

The following ship approvals have been granted to the basic version of 750-438 I/O modules:

	ABS (American Bureau of Shipping)	
	Federal Maritime and Hydrographic Agency	
	BV (Bureau Veritas)	
	DNV (Det Norske Veritas)	Class B
	GL (Germanischer Lloyd)	Cat. A, B, C, D (EMC 1)
	KR (Korean Register of Shipping)	
	LR (Lloyd's Register)	Env. 1, 2, 3, 4
	NKK (Nippon Kaiji Kyokai)	
	PRS (Polski Rejestr Statków)	
	RINA (Registro Italiano Navale)	

3.8 Standards and Guidelines

750-438 I/O modules meet the following standards and guidelines:

EU Directive	2014/34/EU
Explosive atmosphere Devices – General requirements	EN 60079-0
Explosive atmosphere Equipment protection by increased safety "e"	IEC 60079-7
Explosive atmosphere Equipment protection by intrinsic safety "I"	EN 60079-11
Explosive atmosphere Equipment with equipment protection level (EPL) Ga	EN 60079-26

Explosive atmosphere Equipment dust ignition protection by enclosure "t"	EN 60079-31
Explosive atmospheres General requirements	IEC 60079-0
Explosive atmosphere Equipment protection by increased safety "e"	IEC 60079-7
Explosive atmospheres Equipment protection by intrinsic safety "i"	IEC 60079-11
Explosive atmospheres Equipment with equipment protection level (EPL) Ga	IEC 60079-26
Explosive atmospheres Equipment dust ignition protection by enclosure "t"	IEC 60079-31
Explosive atmospheres General requirements	UL 60079-0
Explosive atmospheres Equipment protection by intrinsic safety "i"	UL 60079-11
Explosive atmospheres Equipment protection by type of protection "n"	UL 60079-15
Explosive atmospheres Equipment - General requirements	CAN/CSA-C22.2 No. 60079-0
Explosive atmospheres Equipment Protection by Intrinsic Safety "i"	CAN/CSA-C22.2 No. 60079-11
Explosive atmospheres Equipment Protection by Intrinsic Safety "n"	CAN/CSA-C22.2 No. 60079-15
UL Standard for Safety – for Industrial Control Equipment	UL 508
American National Standard – for Nonincendive Electrical Equipment for Use in Class I and II, Division 2 and Class III. Division 1 and 2 Hazardous (Classified) Location	ANSI/ISA 12.12.01

EU EMC Directive	2014/30/EU
EMC CE-Immunity to interference	EN 61000-6-2 and to EN 61131-2
EMC CE-Emission of interference	EN 61000-6-3 + A1 and IEC 61131-2
EMC marine applications-Emission of interference	acc. to DNV GL
EMC marine applications-Immunity to interference	acc. to DNV GL

4 Process Image

Note



Mapping of process data in the process image of fieldbus systems

The representation of the process data of some I/O modules or their variants in the process image depends on the fieldbus coupler/controller used. Please take this information from the section “I/O Modules” included in the description concerning the process image of the corresponding coupler/controller.

Table 13: Input Bits

		Bit 1	Bit 0
		DI 2	DI 1
DI 1	Signal state DI 1 – digital input channel 1		
DI 2	Signal state DI 2 – digital input channel 2		

5 Mounting

5.1 Mounting Sequence

Fieldbus couplers/controllers and I/O modules of the WAGO-I/O-SYSTEM 750 are snapped directly on a carrier rail in accordance with the European standard EN 50022 (DIN 35).

The reliable positioning and connection is made using a tongue and groove system. Due to the automatic locking, the individual devices are securely seated on the rail after installation.

Starting with the fieldbus coupler/controller, the I/O modules are mounted adjacent to each other according to the project design. Errors in the design of the node in terms of the potential groups (connection via the power contacts) are recognized, as the I/O modules with power contacts (blade contacts) cannot be linked to I/O modules with fewer power contacts.

CAUTION

Risk of injury due to sharp-edged blade contacts!

The blade contacts are sharp-edged. Handle the I/O module carefully to prevent injury.

NOTICE

Insert I/O modules only from the proper direction!

All I/O modules feature grooves for power jumper contacts on the right side. For some I/O modules, the grooves are closed on the top. Therefore, I/O modules featuring a power jumper contact on the left side cannot be snapped from the top. This mechanical coding helps to avoid configuration errors, which may destroy the I/O modules. Therefore, insert I/O modules only from the right and from the top.

Note



Don't forget the bus end module!

Always plug a bus end module (750-600) onto the end of the fieldbus node! You must always use a bus end module at all fieldbus nodes with WAGO-I/O-SYSTEM 750 fieldbus couplers/controllers to guarantee proper data transfer.

5.2 Inserting and Removing Devices

NOTICE

Perform work on devices only if they are de-energized!

Working on energized devices can damage them. Therefore, turn off the power supply before working on the devices.

5.2.1 Inserting the I/O Module

1. Position the I/O module so that the tongue and groove joints to the fieldbus coupler/controller or to the previous or possibly subsequent I/O module are engaged.

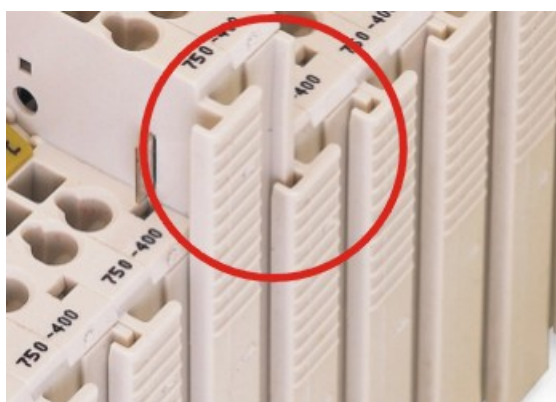

Figure 7: Insert I/O Module (Example)

2. Press the I/O module into the assembly until the I/O module snaps into the carrier rail.

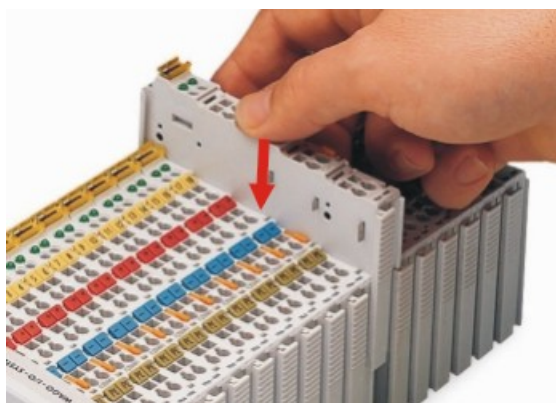

Figure 8: Snap the I/O Module into Place (Example)

With the I/O module snapped in place, the electrical connections for the data contacts and power jumper contacts (if any) to the fieldbus coupler/controller or to the previous or possibly subsequent I/O module are established.

5.2.2 Removing the I/O Module

1. Remove the I/O module from the assembly by pulling the release tab.

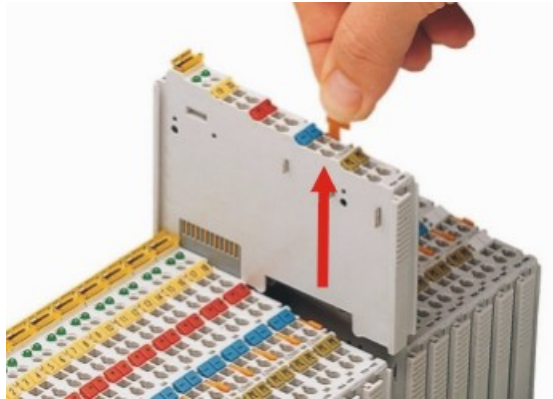

Figure 9: Removing the I/O Module (Example)

Electrical connections for data or power jumper contacts are disconnected when removing the I/O module.

6 Connect Devices

6.1 Connecting a Conductor to the CAGE CLAMP®

The WAGO CAGE CLAMP® connection is appropriate for solid, stranded and finely stranded conductors.

Note



Only connect one conductor to each CAGE CLAMP®!
Only one conductor may be connected to each CAGE CLAMP®.
Do not connect more than one conductor at one single connection!

If more than one conductor must be routed to one connection, these must be connected in an up-circuit wiring assembly, for example using WAGO feed-through terminals.

1. For opening the CAGE CLAMP® insert the actuating tool into the opening above the connection.
2. Insert the conductor into the corresponding connection opening.
3. For closing the CAGE CLAMP® simply remove the tool. The conductor is now clamped firmly in place.

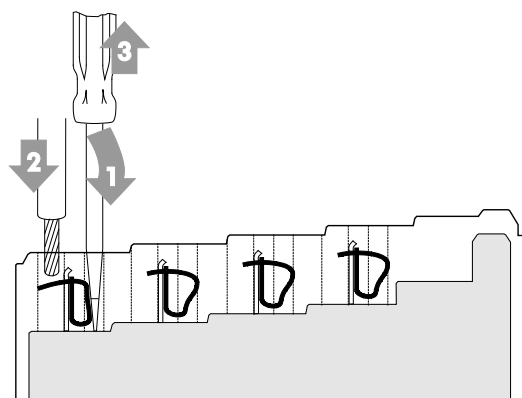

Figure 10: Connecting a Conductor to a CAGE CLAMP®

6.2 Power Supply Concept

WARNING

Ex i I/O modules shall only be supplied via Ex i 24VDC power supply module!

Ex i I/O modules shall only be operated with an Ex i 24VDC power supply module.

WARNING

Keep the air and creep distances between intrinsically safe segments!

The maximum current available from the 750-606 or 750-625/000-001 Ex-i Supply Module is 1 A.

If the use of further DC 24 V Ex i Supply modules is necessary for reasons of extent of utilization, four Separation Modules (750-616) must be used to guarantee the distance between the intrinsically safe segments.

Note



Do not exceed maximum current via power contacts!

The maximum current available from the 750-606 or 750-625/000-001 Ex-i Supply Module is 1 A.

When configuring the system, ensure that this current is not exceeded.

If exceeded, an additional potential feed module must be used.

Information



Further information about explosion prevention!

Further information about explosion prevention can be found in section “Use in Hazardous Environments”!

The Ex i I/O module receives the 24 V voltage supply for the field level from an upstream Ex i I/O module or from an Ex i power supply module via the power contacts used as blade contacts. It then provides this potential to subsequent I/O modules via the power contacts used as spring contacts.

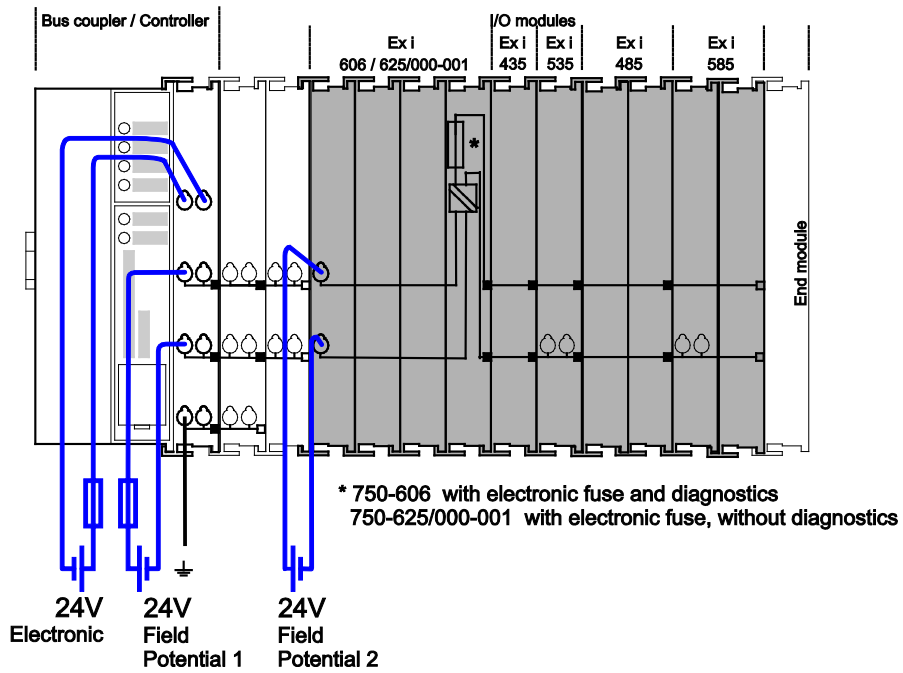

Figure 11: Supply Principle Ex i

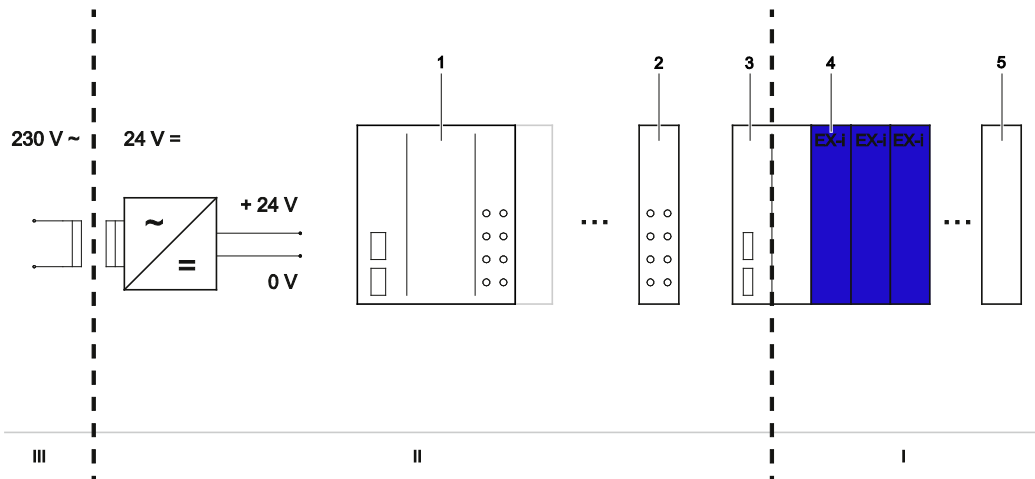

Figure 12: Overvoltage Categories

Table 14: Legend for Figure “Overvoltage Categories”

Pos.	Explanation
1	Fieldbus coupler/controller
2	Filter module
3	Ex i supply module
4	Ex i I/O Modules
5	End module

Both overvoltage categories and rated surge voltage acc. to EN 60664-1:2007 are listed in the appendix.

6.2.1 Power Supply Concept in Marine Applications

⚠ WARNING

The appropriate filter module is required when using Ex i I/O modules in marine applications!

Power supply to the Ex i supply module shall be provided via the appropriate filter module when using Ex i I/O modules in marine applications! Modules approved to category EMC1 (marine applications): 750-626 or 750-626/020-000. Modules approved to category EMC2 (marine applications): 750-626, 750-626/020-000, 750-624 or 750-624/020-000.

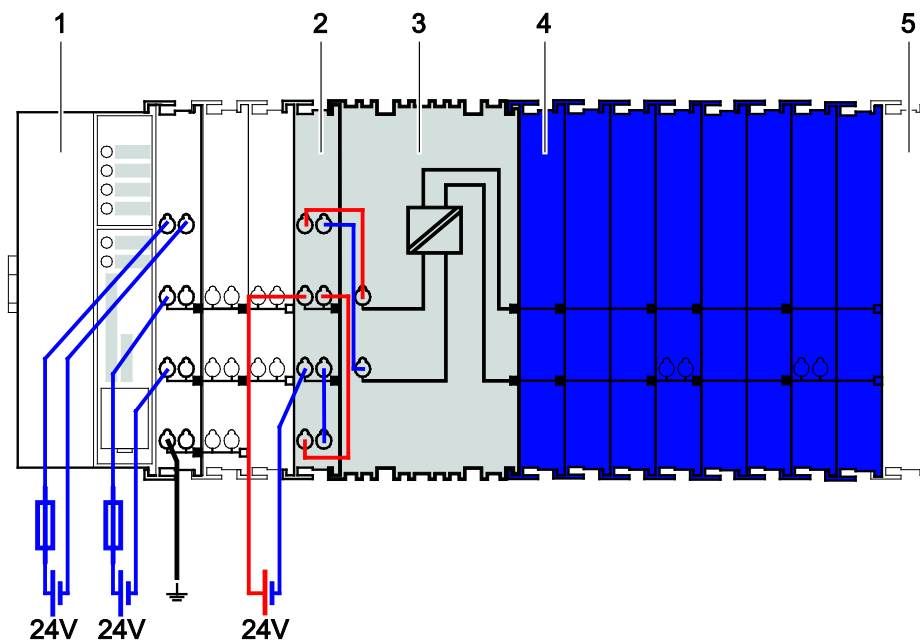

Figure 13: Power Supply Concept, Category EMC1 (Marine Applications)

Table 15: Legend for Figure “Power Supply Concept, Category EMC1 (Marine Applications)”

Pos.	Explanation
1	Fieldbus coupler/controller
2	Filter module (750-626, 750-626/020-000)
3	Ex i supply module (750-606, 750-625/000-001)
4	Ex i I/O Modules
5	End module

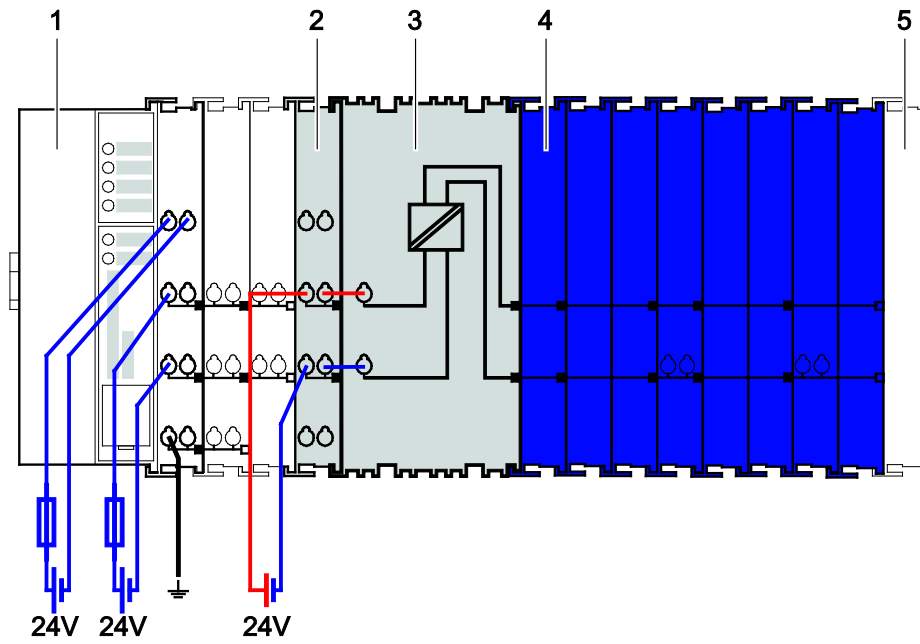

Figure 14: Power Supply Concept, Category EMC2 (Marine Applications)

Table 16: Legend for Figure “Power Supply Concept, Category EMC2 (Marine Applications)”

Pos.	Explanation
1	Fieldbus coupler/controller
2	Filter module (750-626, 750-626/020-000, 750-624, 750-624/020-000)
3	Ex i supply module (750-606, 750-625/000-001)
4	Ex i I/O Modules
5	End module

6.3 Connection Example

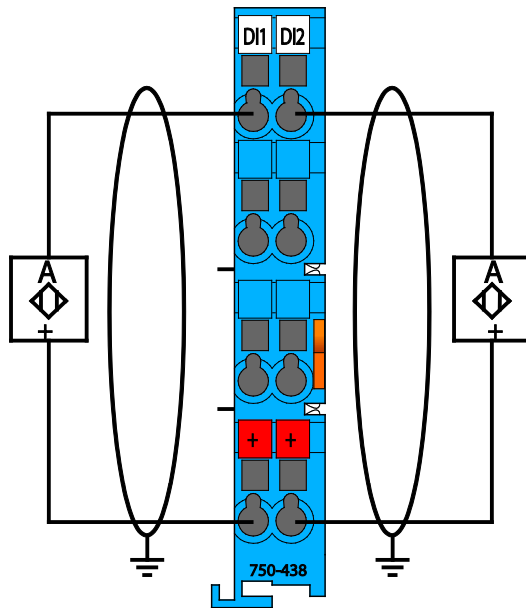

Figure 1: Connecting Diagram

7 Use in Hazardous Environments

The **WAGO-I/O-SYSTEM 750** (electrical equipment) is designed for use in Zone 2 hazardous areas.

The following sections include both the general identification of components (devices) and the installation regulations to be observed. The individual subsections of the “Installation Regulations” section must be taken into account if the I/O module has the required approval or is subject to the range of application of the ATEX directive.

7.1 Marking Configuration Examples

7.1.1 Marking for Europe According to ATEX and IECEx

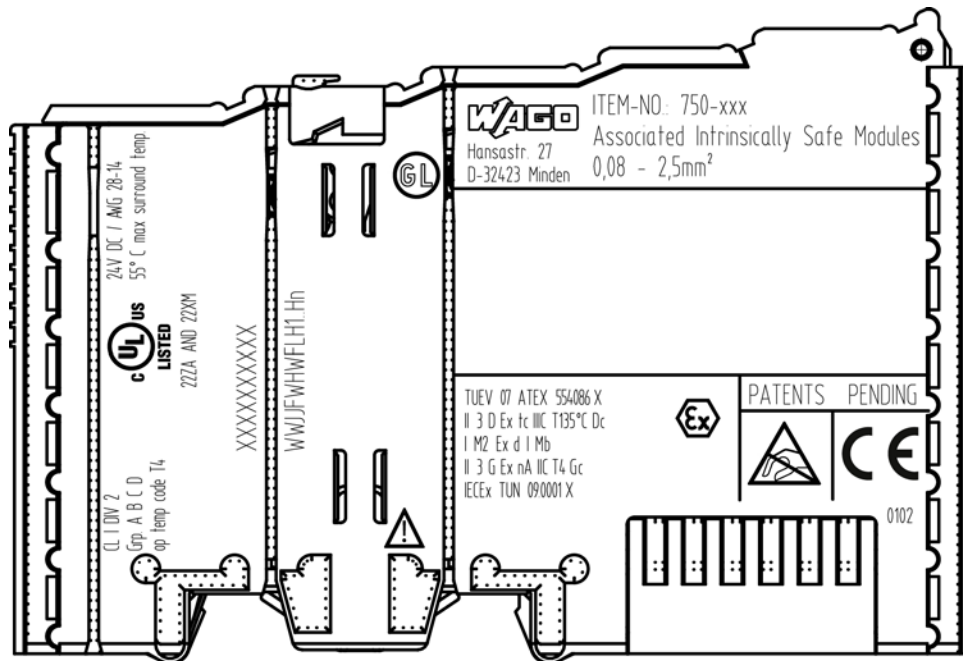

Figure 15: Marking Example According to ATEX and IECEx

TUEV 07 ATEX 554086 X 
 II 3 D Ex tc IIC T135°C Dc
 I M2 Ex d I Mb
 II 3 G Ex nA IIC T4 Gc
 IECEx TUN 090001 X

Figure 16: Text Detail – Marking Example According to ATEX and IECEx

Table 17: Description of Marking Example According to ATEX and IECEx

Marking	Description
TUEV 07 ATEX 554086 X IECEx TUN 09.0001 X	Approving authority resp. certificate numbers
Dust	
II	Equipment group: All except mining
3 D	Category 3 (Zone 22)
Ex	Explosion protection mark
tc	Type of protection: Protection by enclosure
IIIC	Explosion group of dust
T135°C	Max. surface temperature of the enclosure (without a dust layer)
Dc	Equipment protection level (EPL)
Mining	
I	Equipment group: Mining
M2	Category: High level of protection
Ex	Explosion protection mark
d	Type of protection: Flameproof enclosure
I	Explosion group for electrical equipment for mines susceptible to firedamp
Mb	Equipment protection level (EPL)
Gases	
II	Equipment group: All except mining
3 G	Category 3 (Zone 2)
Ex	Explosion protection mark
nA	Type of protection: Non-sparking equipment
IIC	Explosion group of gas and vapours
T4	Temperature class: Max. surface temperature 135 °C
Gc	Equipment protection level (EPL)

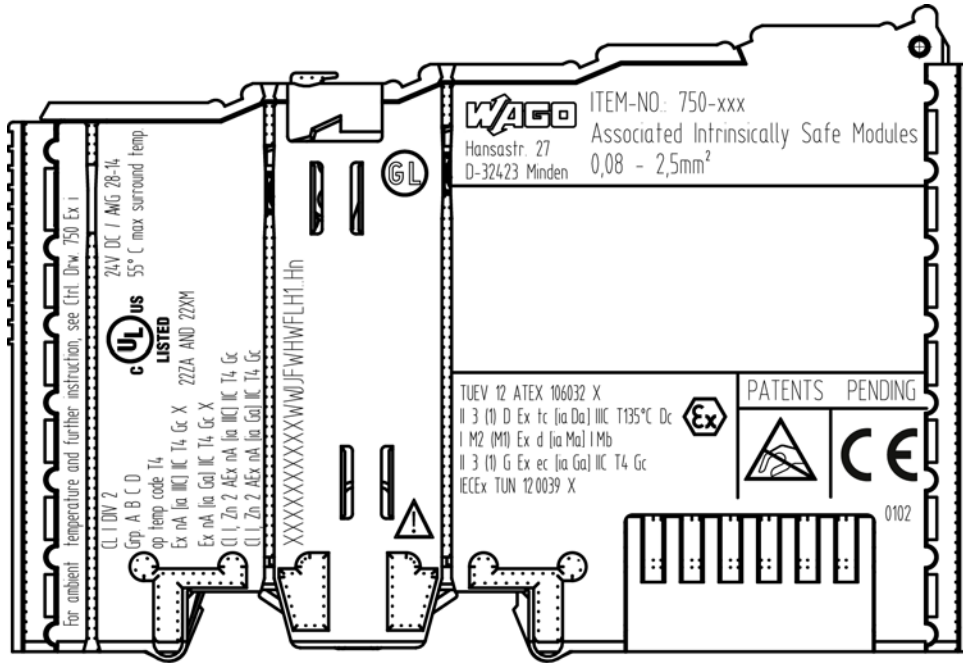

Figure 17: Marking Example for Approved Ex i I/O Module According to ATEX and IECEx

TUEV 12 ATEX 106032 X
 II 3 (1) D Ex tc [ia Da] IIC T135°C Dc
 I M2 (M1) Ex d [ia Ma] I Mb
 II 3 (1) G Ex ec [ia Ga] IIC T4 Gc
 IECEx TUN 120039 X



Figure 18: Text Detail – Marking Example for Approved Ex i I/O Module According to ATEX and IECEx

Table 18: Description of Marking Example for Approved Ex i I/O Module According to ATEX and IECEx

Marking	Description
TUEV 12 ATEX 106032 X IECEx TUN 12 0039 X	Approving authority resp. certificate numbers
Dust	
II	Equipment group: All except mining
3 (1) D	Category 3 (Zone 22) equipment containing a safety device for a category 1 (Zone 20) equipment
Ex	Explosion protection mark
tc	Type of protection: Protection by enclosure
[ia Da]	Type of protection and equipment protection level (EPL): Associated apparatus with intrinsic safety circuits for use in Zone 20
IIIC	Explosion group of dust
T135°C	Max. surface temperature of the enclosure (without a dust layer)
Dc	Equipment protection level (EPL)
Mining	
I	Equipment Group: Mining
M2 (M1)	Category: High level of protection with electrical circuits which present a very high level of protection
Ex	Explosion protection mark
d	Type of protection: Flameproof enclosure
[ia Ma]	Type of protection and equipment protection level (EPL): Associated apparatus with intrinsic safety electrical circuits
I	Explosion group for electrical equipment for mines susceptible to firedamp
Mb	Equipment protection level (EPL)
Gases	
II	Equipment group: All except mining
3 (1) G	Category 3 (Zone 2) equipment containing a safety device for a category 1 (Zone 0) equipment
Ex	Explosion protection mark
ec	Equipment protection by increased safety "e"
[ia Ga]	Type of protection and equipment protection level (EPL): Associated apparatus with intrinsic safety circuits for use in Zone 0
IIIC	Explosion group of gas and vapours
T4	Temperature class: Max. surface temperature 135 °C
Gc	Equipment protection level (EPL)

7.1.2 Marking for America (NEC) and Canada (CEC)

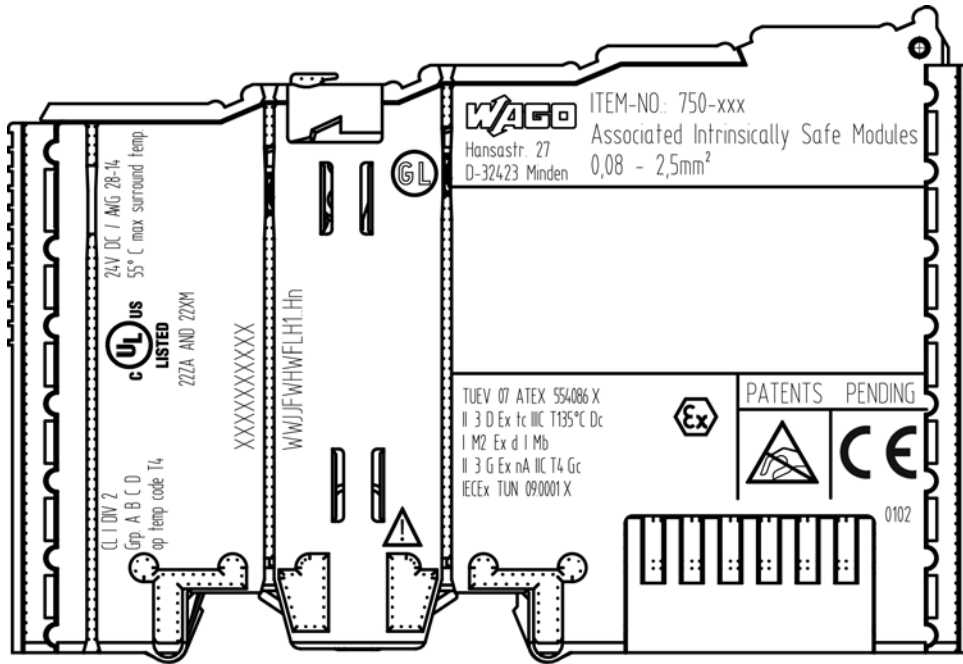

Figure 19: Marking Example According to NEC

CL I DIV 2
Grp. A B C D
op temp code T4

Figure 20: Text Detail – Marking Example According to NEC 500

Table 19: Description of Marking Example According to NEC 500

Marking	Description
CL I	Explosion protection (gas group)
DIV 2	Area of application
Grp. A B C D	Explosion group (gas group)
op temp code T4	Temperature class

CI I, Zn 2 AEx nA [ia Ga] IIC T4 Gc

Figure 21: Text Detail – Marking Example for Approved Ex i I/O Module According to NEC 505

Table 20: Description of Marking Example for Approved Ex i I/O Module According to NEC 505

Marking	Description
CI I,	Explosion protection group
Zn 2	Area of application
AEx	Explosion protection mark
nA	Type of protection
[ia Ga]	Type of protection and equipment protection level (EPL): Associated apparatus with intrinsic safety circuits for use in Zone 20
IIC	Group
T4	Temperature class
Gc	Equipment protection level (EPL)

CI I, Zn 2 AEx nA [ia IIIC] IIC T4 Gc

Figure 22: Text Detail – Marking Example for Approved Ex i I/O Module According to NEC 506

Table 21: Description of Marking Example for Approved Ex i I/O Modules According to NEC 506

Marking	Description
CI I,	Explosion protection group
Zn 2	Area of application
AEx	Explosion protection mark
nA	Type of protection
[ia IIIC]	Type of protection and equipment protection level (EPL): Associated apparatus with intrinsic safety circuits for use in Zone 20
IIC	Group
T4	Temperature class
Gc	Equipment protection level (EPL)

Ex nA [ia IIIC] IIC T4 Gc X
Ex nA [ia Ga] IIC T4 Gc X

Figure 23: Text Detail – Marking Example for Approved Ex i I/O Modules According to CEC 18 attachment J

Table 22: Description of Marking Example for Approved Ex i I/O Modules According to CEC 18 attachment J

Marking	Description
Dust	
Ex	Explosion protection mark
nA	Type of protection
[ia IIIC]	Type of protection and equipment protection level (EPL): Associated apparatus with intrinsic safety circuits for use in Zone 20
IIC	Group
T4	Temperature class
Gc	Equipment protection level (EPL)
X	Symbol used to denote specific conditions of use
Gases	
Ex	Explosion protection mark
nA	Type of protection
[ia Ga]	Type of protection and equipment protection level (EPL): Associated apparatus with intrinsic safety circuits for use in Zone 0
IIC	Group
T4	Temperature class
Gc	Equipment protection level (EPL)
X	Symbol used to denote specific conditions of use

7.2 Installation Regulations

For the installation and operation of electrical equipment in hazardous areas, the valid national and international rules and regulations which are applicable at the installation location must be carefully followed.

7.2.1 Special Notes Regarding Explosion Protection

The following warning notices are to be posted in the immediately proximity of the WAGO-I/O-SYSTEM 750 (hereinafter “product”):

WARNING – DO NOT REMOVE OR REPLACE FUSED WHILE ENERGIZED!

WARNING – DO NOT DISCONNECT WHILE ENERGIZED!

WARNING – ONLY DISCONNECT IN A NON-HAZARDOUS AREA!

Before using the components, check whether the intended application is permitted in accordance with the respective printing. Pay attention to any changes to the printing when replacing components.

The product is an open system. As such, the product must only be installed in appropriate enclosures or electrical operation rooms to which the following applies:

- Can only be opened using a tool or key
- Inside pollution degree 1 or 2
- In operation, internal air temperature within the range of $0\text{ °C} \leq T_a \leq +55\text{ °C}$ or $-20\text{ °C} \leq T_a \leq +60\text{ °C}$ for components with extension number .../025-xxx or $-40\text{ °C} \leq T_a \leq +70\text{ °C}$ for components with extension number .../040-xxx
- Minimum degree of protection: min. IP54 (acc. to EN/IEC 60529)
- For use in Zone 2 (Gc), compliance with the applicable requirements of the standards EN/IEC/ABNT NBR IEC 60079-0, -7, -11, -15
- For use in Zone 22 (Dc), compliance with the applicable requirements of the standards EN/IEC/ABNT NBR IEC 60079-0, -7, -11, -15 and -31
- For use in mining (Mb), minimum degree of protection IP64 (acc. EN/IEC 60529) and adequate protection acc. EN/IEC/ABNT NBR IEC 60079-0 and -1
- Depending on zoning and device category, correct installation and compliance with requirements must be assessed and certified by a “Notified Body” (ExNB) if necessary!

Explosive atmosphere occurring simultaneously with assembly, installation or repair work must be ruled out. Among other things, these include the following activities

- Insertion and removal of components
- Connecting or disconnecting from fieldbus, antenna, D-Sub, ETHERNET or USB connections, DVI ports, memory cards, configuration and programming interfaces in general and service interface in particular:
 - Operating DIP switches, coding switches or potentiometers
 - Replacing fuses

Wiring (connecting or disconnecting) of non-intrinsically safe circuits is only permitted in the following cases

- The circuit is disconnected from the power supply.
- The area is known to be non-hazardous.

Outside the device, suitable measures must be taken so that the rated voltage is not exceeded by more than 40 % due to transient faults (e.g., when powering the field supply).

Product components intended for intrinsically safe applications may only be powered by 750-606 or 750-625/000-001 bus supply modules.

Only field devices whose power supply corresponds to overvoltage category I or II may be connected to these components.

7.2.2 Special Notes Regarding ANSI/ISA Ex

For ANSI/ISA Ex acc. to UL File E198726, the following additional requirements apply:

- Use in Class I, Division 2, Group A, B, C, D or non-hazardous areas only
- ETHERNET connections are used exclusively for connecting to computer networks (LANs) and may not be connected to telephone networks or telecommunication cables
- **WARNING** – The radio receiver module 750-642 may only be used to connect to external antenna 758-910!
- **WARNING** – Product components with fuses must not be fitted into circuits subject to overloads!
These include, e.g., motor circuits.
- **WARNING** – When installing I/O module 750-538, “Control Drawing No. 750538” in the manual must be strictly observed!



Information

Additional Information

Proof of certification is available on request.

Also take note of the information given on the operating and assembly instructions.

The manual, containing these special conditions for safe use, must be readily available to the user.

8 Appendix

8.1 Rated Surge Voltage

Table 23: Rated Surge Voltage^{*)}

Nominal voltage of the power supply system (mains) acc. to IEC 60038 3		Line-to-neutral voltage, derived from the nominal AC or DC voltage up to and including	Rated surge voltage			
Three-phase	Single-phase		Overvoltage category			
			I	II	III	IV
		50 V	330 V	500 V	800 V	1500 V
		100 V	500 V	800 V	1500 V	2500 V
	120 V ... 240 V	150 V	800 V	1500 V	2500 V	4000 V
230 V / 400 V 277 V / 480 V		300 V	1500 V	2500 V	4000 V	6000 V
400 V / 690 V		600 V	2500 V	4000 V	6000 V	8000 V
1000 V		1000 V	4000 V	6000 V	8000 V	12000 V

^{*)} Source: EN 60664-1:2007, Appendix F.1

List of Figures

Figure 1: View	14
Figure 2: Data Contacts	15
Figure 3: Power Jumper Contacts	16
Figure 4: CAGE CLAMP® Connectors	17
Figure 5: Display Elements	17
Figure 6: Schematic Diagram	19
Figure 7: Insert I/O Module (Example)	29
Figure 8: Snap the I/O Module into Place (Example)	29
Figure 9: Removing the I/O Module (Example)	30
Figure 10: Connecting a Conductor to a CAGE CLAMP®	31
Figure 11: Supply Principle Ex i	33
Figure 12: Overvoltage Categories	33
Figure 13: Power Supply Concept, Category EMC1 (Marine Applications)	34
Figure 14: Power Supply Concept, Category EMC2 (Marine Applications)	35
Figure 15: Marking Example According to ATEX and IECEX	38
Figure 16: Text Detail – Marking Example According to ATEX and IECEX	38
Figure 17: Marking Example for Approved Ex i I/O Module According to ATEX and IECEX	40
Figure 18: Text Detail – Marking Example for Approved Ex i I/O Module According to ATEX and IECEX	40
Figure 19: Marking Example According to NEC	42
Figure 20: Text Detail – Marking Example According to NEC 500	42
Figure 21: Text Detail – Marking Example for Approved Ex i I/O Module According to NEC 505	43
Figure 22: Text Detail – Marking Example for Approved Ex i I/O Module According to NEC 506	43
Figure 23: Text Detail – Marking Example for Approved Ex i I/O Modules According to CEC 18 attachment J	44

List of Tables

Table 1: Number Notation.....	8
Table 2: Font Conventions	8
Table 3: Legend for Figure “View”	14
Table 4: Legend for Figure “Power Jumper Contacts”	16
Table 5: Legend for Figure “CAGE CLAMP® Connectors”	17
Table 6: Legend for Figure “Display Elements”	18
Table 7: Technical Data – Device	20
Table 8: Technical Data – Explosion Protection.....	21
Table 9: Technical Data – Field Wiring.....	21
Table 10: Technical Data – Power Jumper Contacts	22
Table 11: Technical Data – Data Contacts	22
Table 12: Technical Data – Climatic Environmental Conditions	22
Table 13: Input Bits.....	27
Table 14: Legend for Figure “Overvoltage Categories”	33
Table 15: Legend for Figure “Power Supply Concept, Category EMC1 (Marine Applications)”	34
Table 16: Legend for Figure “Power Supply Concept, Category EMC2 (Marine Applications)”	35
Table 17: Description of Marking Example According to ATEX and IECEx	39
Table 18: Description of Marking Example for Approved Ex i I/O Module According to ATEX and IECEx	41
Table 19: Description of Marking Example According to NEC 500.....	42
Table 20: Description of Marking Example for Approved Ex i I/O Module According to NEC 505.....	43
Table 21: Description of Marking Example for Approved Ex i I/O Modules According to NEC 506.....	43
Table 22: Description of Marking Example for Approved Ex i I/O Modules According to CEC 18 attachment J.....	44
Table 23: Rated Surge Voltage ^{*)}	48

WE! INNOVATE!

WAGO Kontakttechnik GmbH & Co. KG
Postfach 2880 • D-32385 Minden
Hansastraße 27 • D-32423 Minden
Phone: 05 71/8 87 – 0
Fax: 05 71/8 87 – 1 69
E-Mail: info@wago.com
Internet: <http://www.wago.com>

