

# WAGO-I/O-SYSTEM 750

## Manual

---



---

**750-465(/xxx-xxx)**  
**2AI 0-20mA S.E.**  
**2-Channel Analog Input Module 0-20 mA,**  
**Single-Ended**

Version 1.1.0

© 2015 by WAGO Kontakttechnik GmbH & Co. KG  
All rights reserved.

### **WAGO Kontakttechnik GmbH & Co. KG**

Hansastraße 27  
D-32423 Minden

Phone: +49 (0) 571/8 87 – 0  
Fax: +49 (0) 571/8 87 – 1 69

E-Mail: [info@wago.com](mailto:info@wago.com)

Web: <http://www.wago.com>

### **Technical Support**

Phone: +49 (0) 571/8 87 – 5 55  
Fax: +49 (0) 571/8 87 – 85 55

E-Mail: [support@wago.com](mailto:support@wago.com)

Every conceivable measure has been taken to ensure the accuracy and completeness of this documentation. However, as errors can never be fully excluded, we always appreciate any information or suggestions for improving the documentation.

E-Mail: [documentation@wago.com](mailto:documentation@wago.com)

We wish to point out that the software and hardware terms as well as the trademarks of companies used and/or mentioned in the present manual are generally protected by trademark or patent.

# Table of Contents

<b>1</b>	<b>Notes about this Documentation.....</b>	<b>5</b>
1.1	Validity of this Documentation.....	5
1.2	Copyright.....	5
1.3	Symbols.....	7
1.4	Number Notation.....	9
1.5	Font Conventions.....	9
<b>2</b>	<b>Important Notes .....</b>	<b>10</b>
2.1	Legal Bases .....	10
2.1.1	Subject to Changes .....	10
2.1.2	Personnel Qualifications.....	10
2.1.3	Use of the WAGO-I/O-SYSTEM 750 in Compliance with Underlying Provisions.....	10
2.1.4	Technical Condition of Specified Devices.....	11
2.2	Safety Advice (Precautions).....	12
<b>3</b>	<b>Device Description .....</b>	<b>14</b>
3.1	View .....	16
3.2	Connectors.....	17
3.2.1	Data Contacts/Internal Bus.....	17
3.2.2	Power Jumper Contacts/Field Supply .....	18
3.2.3	CAGE CLAMP® Connectors .....	20
3.3	Display Elements .....	21
3.4	Schematic Diagram .....	22
3.5	Technical Data .....	23
3.5.1	Device.....	23
3.5.2	Supply.....	23
3.5.3	Communication .....	23
3.5.4	Inputs .....	23
	Connection Type .....	24
3.5.5	Climatic Environmental Conditions.....	24
3.6	Approvals .....	25
3.7	Standards and Guidelines.....	26
<b>4</b>	<b>Process Image.....</b>	<b>27</b>
4.1	Standard Format .....	28
4.2	Special Formats .....	29
<b>5</b>	<b>Mounting.....</b>	<b>30</b>
5.1	Mounting Sequence.....	30
5.2	Inserting and Removing Devices .....	31
5.2.1	Inserting the I/O Module .....	31
5.2.2	Removing the I/O Module.....	32
<b>6</b>	<b>Connect Devices .....</b>	<b>33</b>
6.1	Connecting a Conductor to the CAGE CLAMP® .....	33
6.2	Connection Examples.....	34
6.2.1	2-Wire Connection 0 V .....	34
6.2.2	2-Wire Connection 24 V .....	35

---

6.2.3	3-Wire Connection .....	36
<b>7</b>	<b>Use in Hazardous Environments .....</b>	<b>37</b>
7.1	Marking Configuration Examples.....	38
7.1.1	Marking for Europe According to ATEX and IEC-Ex .....	38
7.1.2	Marking for America According to NEC 500 .....	43
7.2	Installation Regulations.....	44
7.2.1	Special Conditions for Safe Use (ATEX Certificate TÜV 07 ATEX 554086 X).....	45
7.2.2	Special Conditions for Safe Use (ATEX Certificate TÜV 12 ATEX 106032 X).....	46
7.2.3	Special Conditions for Safe Use (IEC-Ex Certificate TUN 09.0001 X).....	47
7.2.4	Special Conditions for Safe Use (IEC-Ex Certificate IECEX TUN 12.0039 X).....	48
7.2.5	Special Conditions for Safe Use According to ANSI/ISA 12.12.01 .....	49
	<b>List of Figures .....</b>	<b>50</b>
	<b>List of Tables.....</b>	<b>51</b>

# 1 Notes about this Documentation

## Note



### Always retain this documentation!

This documentation is part of the product. Therefore, retain the documentation during the entire service life of the product. Pass on the documentation to any subsequent user. In addition, ensure that any supplement to this documentation is included, if necessary.

## 1.1 Validity of this Documentation

This documentation is only applicable to the I/O module 750-465 (2AI 0-20mA S.E.) and the variants listed in the table below.

Table 1: Versions

Item No./Version	Description
750-465	2AI 0-20mA S.E.
750-465/000-002	2AI 0-20mA S.E. with RC low pass ( $P_{T2} / f_{3dB} = 5 \text{ Hz}$ )
750-465/000-200	2AI 0-20mA S.E. with Siemens format (S5-FB 250)
750-465/025-000	2AI 0-20mA S.E./T (extended temperature range)

## Note



### Documentation Validity for Variants

Unless otherwise indicated, the information given in this documentation applies to listed variants.

The I/O module 750-465 shall only be installed and operated according to the instructions in this manual and in the manual for the used fieldbus coupler/controller.

## NOTICE

### Consider power layout of the WAGO-I/O-SYSTEM 750!

In addition to these operating instructions, you will also need the manual for the used fieldbus coupler/controller, which can be downloaded at [www.wago.com](http://www.wago.com). There, you can obtain important information including information on electrical isolation, system power and supply specifications.

## 1.2 Copyright

This Manual, including all figures and illustrations, is copyright-protected. Any further use of this Manual by third parties that violate pertinent copyright provisions is prohibited. Reproduction, translation, electronic and phototechnical

filing/archiving (e.g., photocopying) as well as any amendments require the written consent of WAGO Kontakttechnik GmbH & Co. KG, Minden, Germany. Non-observance will involve the right to assert damage claims.

## 1.3 Symbols

---

 **DANGER**

**Personal Injury!**

Indicates a high-risk, imminently hazardous situation which, if not avoided, will result in death or serious injury.

---

---

 **DANGER**

**Personal Injury Caused by Electric Current!**

Indicates a high-risk, imminently hazardous situation which, if not avoided, will result in death or serious injury.

---

---

 **WARNING**

**Personal Injury!**

Indicates a moderate-risk, potentially hazardous situation which, if not avoided, could result in death or serious injury.

---

---

 **CAUTION**

**Personal Injury!**

Indicates a low-risk, potentially hazardous situation which, if not avoided, may result in minor or moderate injury.

---

---

**NOTICE**

**Damage to Property!**

Indicates a potentially hazardous situation which, if not avoided, may result in damage to property.

---

---

**NOTICE**

**Damage to Property Caused by Electrostatic Discharge (ESD)!**

Indicates a potentially hazardous situation which, if not avoided, may result in damage to property.

---

---

**Note**

**Important Note!**

Indicates a potential malfunction which, if not avoided, however, will not result in damage to property.

---

---

## *Information*

**Additional Information:**

Refers to additional information which is not an integral part of this documentation (e.g., the Internet).

---



## 1.4 Number Notation

Table 2: Number Notation

Number Code	Example	Note
Decimal	100	Normal notation
Hexadecimal	0x64	C notation
Binary	'100' '0110.0100'	In quotation marks, nibble separated with dots (.)

## 1.5 Font Conventions

Table 3: Font Conventions

Font Type	Indicates
<i>italic</i>	Names of paths and data files are marked in italic-type. e.g.: <i>C:\Program Files\WAGO Software</i>
<b>Menu</b>	Menu items are marked in bold letters. e.g.: <b>Save</b>
>	A greater-than sign between two names means the selection of a menu item from a menu. e.g.: <b>File &gt; New</b>
<b>Input</b>	Designation of input or optional fields are marked in bold letters, e.g.: <b>Start of measurement range</b>
“Value”	Input or selective values are marked in inverted commas. e.g.: Enter the value “4 mA” under <b>Start of measurement range</b> .
<b>[Button]</b>	Pushbuttons in dialog boxes are marked with bold letters in square brackets. e.g.: <b>[Input]</b>
<b>[Key]</b>	Keys are marked with bold letters in square brackets. e.g.: <b>[F5]</b>

## 2 Important Notes

This section includes an overall summary of the most important safety requirements and notes that are mentioned in each individual section. To protect your health and prevent damage to devices as well, it is imperative to read and carefully follow the safety guidelines.

### 2.1 Legal Bases

#### 2.1.1 Subject to Changes

WAGO Kontakttechnik GmbH & Co. KG reserves the right to provide for any alterations or modifications that serve to increase the efficiency of technical progress. WAGO Kontakttechnik GmbH & Co. KG owns all rights arising from the granting of patents or from the legal protection of utility patents. Third-party products are always mentioned without any reference to patent rights. Thus, the existence of such rights cannot be excluded.

#### 2.1.2 Personnel Qualifications

All sequences implemented on WAGO-I/O-SYSTEM 750 devices may only be carried out by electrical specialists with sufficient knowledge in automation. The specialists must be familiar with the current norms and guidelines for the devices and automated environments.

All changes to the coupler or controller should always be carried out by qualified personnel with sufficient skills in PLC programming.

#### 2.1.3 Use of the WAGO-I/O-SYSTEM 750 in Compliance with Underlying Provisions

Fieldbus couplers, fieldbus controllers and I/O modules found in the modular WAGO-I/O-SYSTEM 750 receive digital and analog signals from sensors and transmit them to actuators or higher-level control systems. Using programmable controllers, the signals can also be (pre-) processed.

The devices have been developed for use in an environment that meets the IP20 protection class criteria. Protection against finger injury and solid impurities up to 12.5 mm diameter is assured; protection against water damage is not ensured. Unless otherwise specified, operation of the devices in wet and dusty environments is prohibited.

Operating the WAGO-I/O-SYSTEM 750 devices in home applications without further measures is only permitted if they meet the emission limits (emissions of interference) according to EN 61000-6-3. You will find the relevant information in the section “Device Description” > “Standards and Guidelines” in the manual for the used fieldbus coupler/controller.

Appropriate housing (per 94/9/EG) is required when operating the WAGO-I/O-SYSTEM 750 in hazardous environments. Please note that a prototype test certificate must be obtained that confirms the correct installation of the system in a housing or switch cabinet.

#### **2.1.4 Technical Condition of Specified Devices**

The devices to be supplied ex works are equipped with hardware and software configurations, which meet the individual application requirements. WAGO Kontakttechnik GmbH & Co. KG will be exempted from any liability in case of changes in hardware or software as well as to non-compliant usage of devices.

Please send your request for modified and new hardware or software configurations directly to WAGO Kontakttechnik GmbH & Co. KG.

## 2.2 Safety Advice (Precautions)

For installing and operating purposes of the relevant device to your system the following safety precautions shall be observed:



### **DANGER**

#### **Do not work on devices while energized!**

All power sources to the device shall be switched off prior to performing any installation, repair or maintenance work.

### **DANGER**

#### **Install the device only in appropriate housings, cabinets or in electrical operation rooms!**

The WAGO-I/O-SYSTEM 750 and its components are an open system. As such, install the system and its components exclusively in appropriate housings, cabinets or in electrical operation rooms. Allow access to such equipment and fixtures to authorized, qualified staff only by means of specific keys or tools.

### **NOTICE**

#### **Replace defective or damaged devices!**

Replace defective or damaged device/module (e.g., in the event of deformed contacts), since the long-term functionality of device/module involved can no longer be ensured.

### **NOTICE**

#### **Protect the components against materials having seeping and insulating properties!**

The components are not resistant to materials having seeping and insulating properties such as: aerosols, silicones and triglycerides (found in some hand creams). If you cannot exclude that such materials will appear in the component environment, then install the components in an enclosure being resistant to the above-mentioned materials. Clean tools and materials are imperative for handling devices/modules.

### **NOTICE**

#### **Clean only with permitted materials!**

Clean soiled contacts using oil-free compressed air or with ethyl alcohol and leather cloths.

---

## NOTICE

**Do not use any contact spray!**

Do not use any contact spray. The spray may impair contact area functionality in connection with contamination.

---

---

## NOTICE

**Do not reverse the polarity of connection lines!**

Avoid reverse polarity of data and power supply lines, as this may damage the devices involved.

---

---

## NOTICE



**Avoid electrostatic discharge!**

The devices are equipped with electronic components that may be destroyed by electrostatic discharge when touched. Please observe the safety precautions against electrostatic discharge per DIN EN 61340-5-1/-3. When handling the devices, please ensure that environmental factors (personnel, work space and packaging) are properly grounded.

---

### 3 Device Description

The Analog Input Module 750-465 (2AI 0-20mA S.E.) processes analog signals with the norm value of 0 mA ... 20 mA.

Two- or three-wire transducers without power supply (e.g., adjustable resistors, pressure, flow and level meters) can be connected directly.

The transducers are directly supplied with 24 V from the I/O module.

2-wire signal conditioners are powered by the 24V connections. The 3-wire signal conditioners are powered by the 24V and 0V connections.

The I/O module has 2 input channels for fieldside signals. The sensors may be received via the CAGE CLAMP® connections AI 1 or AI 2.

The channels have a common reference potential and a shield connection. The shield connection is fed directly to the carrier rail and contact is made automatically by snapping the module onto the rail.

The assignment of the connections is described in the “Connectors” section. Connection examples are shown in section “Connecting Devices” > ... > “Connection Example(s)”.

The input signal is electrically isolated and is transmitted with a resolution of 12 bits.

The operational readiness and the trouble-free internal data bus communication of the channels are indicated via a green function LED.

For each channel, a red error LED indicates a measuring overrange.

The meaning of the LEDs is described in the “Display Elements” section.

The I/O module 750-465 (2AI 0-20mA S.E.) receives the 24 V voltage supply for the field level from an upstream I/O module or from the fieldbus coupler/controller via blade-formed power jumper contacts. It then provides these potentials to subsequent I/O modules via spring-formed power jumper contacts.

#### NOTICE

**Do not exceed maximum current via power jumper contacts!**

The maximum current to flow through the power jumper contacts is 10 A. Greater currents can damage the contacts.

When configuring your system, ensure that this current is not exceeded. If exceeded, insert an additional supply module.

With consideration of the power jumper contacts, the individual modules can be arranged in any combination when configuring the fieldbus node. An arrangement in groups within the group of potentials is not necessary.

The I/O module 750-465 can be used with all fieldbus couplers/controllers of the WAGO-I/O-SYSTEM 750 (except for the economy types 750-320, -323, -324 and -327).

### 3.1 View

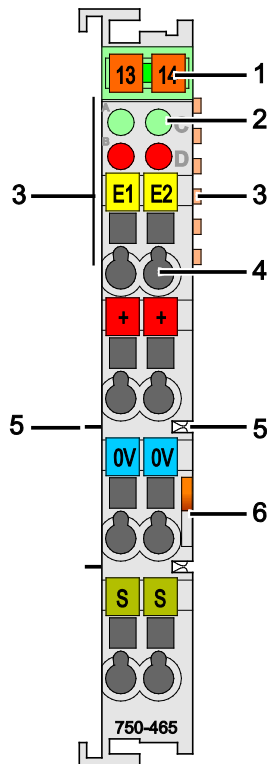

Figure 1: View

Table 4: Legend for Figure “View”

Pos.	Description	Details See Section
1	Marking possibility with Mini-WSB	---
2	Status LEDs	“Device Description” > “Display Elements”
3	Data contacts	“Device Description” > “Connectors”
4	CAGE CLAMP® connectors	“Device Description” > “Connectors”
5	Power jumper contacts	“Device Description” > “Connectors”
6	Release tab	“Mounting” > “Inserting and Removing Devices”



## 3.2 Connectors

### 3.2.1 Data Contacts/Internal Bus

Communication between the fieldbus coupler/controller and the I/O modules as well as the system supply of the I/O modules is carried out via the internal bus. It is comprised of 6 data contacts, which are available as self-cleaning gold spring contacts.

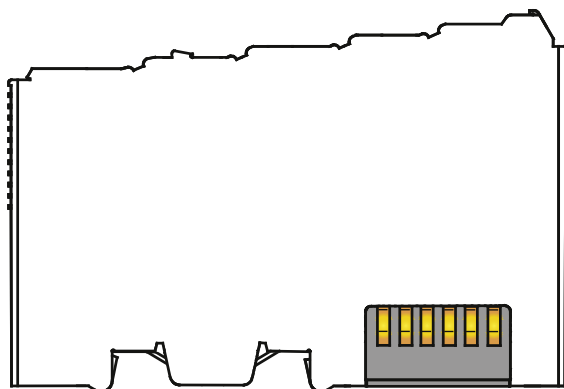

Figure 2: Data Contacts

#### NOTICE

**Do not place the I/O modules on the gold spring contacts!**

Do not place the I/O modules on the gold spring contacts in order to avoid soiling or scratching!

#### NOTICE



**Ensure that the environment is well grounded!**

The devices are equipped with electronic components that may be destroyed by electrostatic discharge. When handling the devices, ensure that the environment (persons, workplace and packing) is well grounded. Avoid touching conductive components, e.g. data contacts.

### 3.2.2 Power Jumper Contacts/Field Supply

#### **⚠ CAUTION**

##### **Risk of injury due to sharp-edged blade contacts!**

The blade contacts are sharp-edged. Handle the I/O module carefully to prevent injury.

The I/O module 750-465 has 2 self-cleaning power jumper contacts that supply and transmit power for the field side. The contacts on the left side of the I/O module are designed as blade contacts and those on the right side as spring contacts.

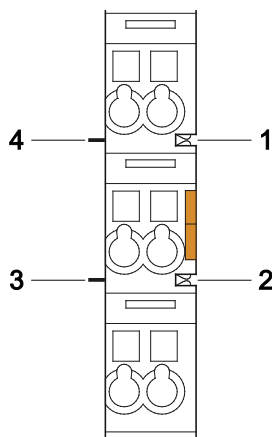

Figure 3: Power Jumper Contacts

Table 5: Legend for Figure “Power Jumper Contacts”

Contact	Type	Function
1	Spring contact	Potential transmission ( $U_V$ ) for field supply
2	Spring contact	Potential transmission (0 V) for field supply
3	Blade contact	Potential feed-in (0 V) for field supply
4	Blade contact	Potential feed-in ( $U_V$ ) for field supply

#### **NOTICE**

##### **Do not exceed maximum current via power jumper contacts!**

The maximum current to flow through the power jumper contacts is 10 A. Greater currents can damage the contacts.

When configuring your system, ensure that this current is not exceeded. If exceeded, insert an additional supply module.

## Note



### **Use supply modules for ground (earth)!**

The I/O module has no power jumper contacts for receiving and transmitting the earth potential. Use a supply module when an earth potential is needed for the subsequent I/O modules.

### 3.2.3 CAGE CLAMP® Connectors

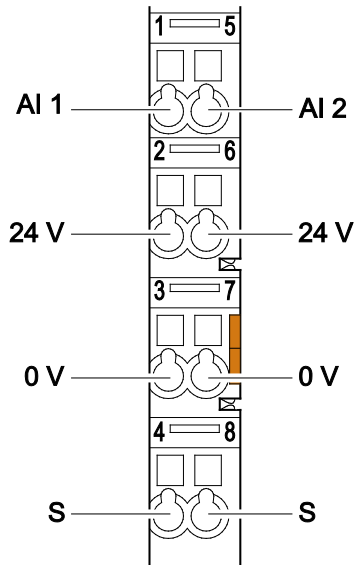

Figure 4: CAGE CLAMP® Connectors

Table 6: Legend for Figure „CAGE CLAMP® Connectors”

Channel	Designation	Connector	Function
1	AI 1	1	Current signal
	24 V	2	Field supply $U_v$
	0 V	3	Field supply 0 V
	S	4	Shield
2	AI 2	5	Current signal
	24 V	6	Field supply $U_v$
	0 V	7	Field supply 0 V
	S	8	Shield



## Note

### Use shielded signal lines!

Only use shielded signal lines for analog signals and I/O modules which are equipped with shield clamps. Only then can you ensure that the accuracy and interference immunity specified for the respective I/O module can be achieved even in the presence of interference acting on the signal cable.

### 3.3 Display Elements

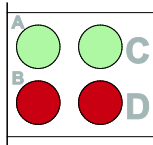

Figure 5: Display Elements

Table 7: Legend for Figure “Display Elements”

Channel	Designation	LED	State	Function
1	Function AI 1	A	Off	Not ready for operation or no or disturbed internal bus communication
			Green	Operational readiness and trouble-free internal data bus communication
	Error AI 1	B	Off	Normal operation
			Red	Overrange of the admissible measuring range
2	Function AI 2	C	Off	Not ready for operation or no or disturbed internal bus communication
			Green	Operational readiness and trouble-free internal data bus communication
	Error AI 2	D	Off	Normal operation
			Red	Overrange of the admissible measuring range

### 3.4 Schematic Diagram

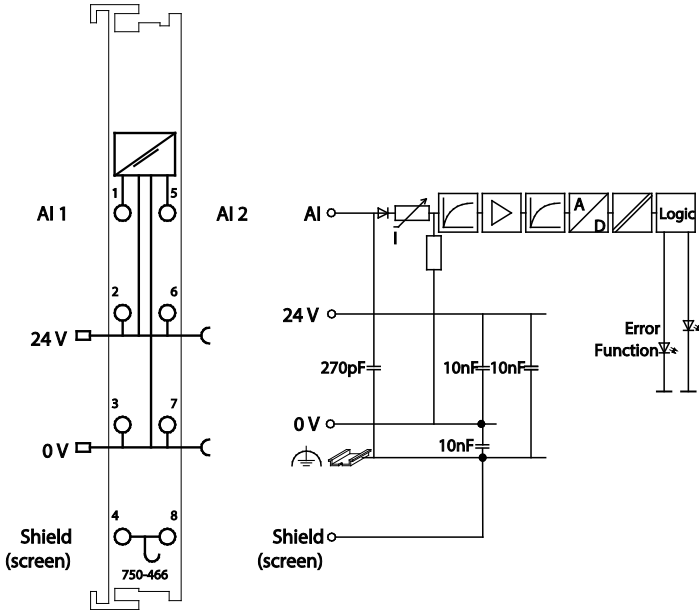

Figure 6: Schematic Diagram

## 3.5 Technical Data

### 3.5.1 Device

Table 8: Technical Data – Device

Width	12 mm
Height (from upper edge of 35 DIN rail)	64 mm
Depth	100 mm
Weight	Approx. 51 g

### 3.5.2 Supply

Table 9: Technical Data – Supply

Voltage supply	Via system voltage terminal bus (5 V DC) and power contacts (24 V DC)
Current consumption (5 V DC system voltage) <sub>typ.</sub>	75 mA
Current consumption (24 V DC power jumper contacts) <sub>max.</sub>	---
Voltage via power contacts	24 V DC
Current via power contacts <sub>max.</sub>	10 A
Isolation (peak value)	500 V System/Supply

### 3.5.3 Communication

Table 10: Technical Data – Communication

Internal bit width (internal bus)	2 × 16 bits data
2-Channel operation	2 × 8 bits control/status (optional)

### 3.5.4 Inputs

Table 11: Technical Data – Inputs

No. of inputs	2
Sensor connection	2-, 3-conductor connection
Conversion time	2 ms
Resolution	12 Bit
Measurement deviation at 25°C	≤ ±0,2 % of full scale value
Temperature coefficient	< ±0,01 %/ K of full scale value
Signal current	0 mA ... 20 mA
Input voltage <sub>max.</sub>	10 V
Input resistance <sub>typ.</sub>	< 220 Ω at 20 mA

## Connection Type

Table 12: Technical Data – Field Wiring

Wire connection	CAGE CLAMP®
Cross section	0.08 mm <sup>2</sup> ... 2.5 mm <sup>2</sup> , AWG 28 ... 14
Stripped lengths	8 mm ... 9 mm / 0.33 in

Table 13: Technical Data – Power Jumper Contacts

Power jumper contacts	Blade/spring contact, self-cleaning
Voltage drop at I <sub>max.</sub>	< 1 V/64 modules

Table 14: Technical Data – Data Contacts

Data contacts	Slide contact, hard gold plated, self-cleaning
---------------	--

### 3.5.5 Climatic Environmental Conditions

Table 15: Technical Data – Climatic Environmental Conditions

Operating temperature range	0 °C ... 55 °C
Operating temperature range for components with extended temperature range (750-xxx/025-xxx)	-20 °C ... +60 °C
Storage temperature range	-25 °C ... +85 °C
Storage temperature range for components with extended temperature range (750-xxx/025-xxx)	-40 °C ... +85 °C
Relative humidity	Max. 5 % ... 95 % without condensation
Resistance to harmful substances	Acc. to IEC 60068-2-42 and IEC 60068-2-43
Maximum pollutant concentration at relative humidity < 75 %	SO <sub>2</sub> ≤ 25 ppm H <sub>2</sub> S ≤ 10 ppm
Special conditions	Ensure that additional measures for components are taken, which are used in an environment involving: – dust, caustic vapors or gases – ionizing radiation



## 3.6 Approvals

The following approvals have been granted to the basic version and all variants of 750-465 I/O modules:

 Conformity Marking

 cUL<sub>US</sub> UL508

The following approvals have been granted to the basic version of 750-465 I/O modules and to all its variants, except for the 750-465/000-002 variant:

 Korea Certification MSIP-REM-W43-AIM750

The following Ex approvals have been granted to the basic version of 750-465 I/O modules and to all its variants, except for the 750-465/000-002 variant:

 TÜV 07 ATEX 554086 X  
I M2 Ex d I Mb  
II 3 G Ex nA IIC T4 Gc  
II 3 D Ex tc IIIC T135°C Dc  
IECEX TUN 09.0001 X  
Ex d I Mb  
Ex nA IIC T4 Gc  
Ex tc IIIC T135°C Dc

The following Ex approvals have been granted to the basic version and all variants of 750-465 I/O modules:

 cUL<sub>US</sub> ANSI/ISA 12.12.01  
Class I, Div2 ABCD T4

---

### Information



#### More information about approvals.

Detailed references to the approvals are listed in the document “Overview Approvals **WAGO-I/O-SYSTEM 750**”, which you can find via the internet under: [www.wago.com](http://www.wago.com) > SERVICES > DOWNLOADS > Additional documentation and information on automation products > WAGO-I/O-SYSTEM 750 > System Description.

---

### 3.7 Standards and Guidelines

All variations of 750-465 I/O modules meet the following requirements on emission and immunity of interference:

EMC CE-Immunity to interference      acc. to EN 61000-6-2

EMC CE-Emission of interference      acc. to EN 61000-6-4

## 4 Process Image

**Note:**



### **Mapping the Process Image in the Fieldbus System**

Mapping the I/O module process data in the process image of the fieldbus system depends on the fieldbus-controller used. This information, as well as the specific configuration for relevant control/status bytes is located in the section “Fieldbus-Specific Configuration of Process Data.” This section describes the process image of the particular fieldbus coupler/controller.

The 750-465 analog input module provides 1 status byte (8 bits) and 1 data word (16 bits) per channel.

The digitalized measured value is transmitted to the process image of the coupler/controller in a data word (16 bits) as input byte “0” (low) and input byte “1” (high).

The digitalized value is mapped with a resolution of 12 bits to bit B3 ... B14. From production number 3202XXXX, status information, which can be evaluated in the event of an error, is contained in the three least significant bits (B0 ... B2). In the event of an overrange, bit B0 = 1 is set.

With modules with an earlier production number, these last 3 bits are not evaluated.

The production number is printed on the side of the module housing.

## 4.1 Standard Format

For the standard module 750-465 and the versions 750-465/000-002 and 750-465/025-000, the input current range 0 mA ... 20 mA is scaled to the numerical value range 0x0000 ... 0x7FF9.

Table 16: Process Image – Standard Module 750-465 and Versions 750-465/000-002 and 750-465/025-000

Input current 0 mA - 20 mA	Numeric value				Status Byte Hex.	LED Error AI 1, 2
	Binary Measured value	*)XFÜ	Hex.	Dec.		
< 0.0	Not possible (reverse voltage protection)					
0.0	'0000.0000.0000.0	000'	0x0000	0	0x00	OFF
2.5	'0001.0000.0000.0	000'	0x1000	4096	0x00	OFF
5.0	'0010.0000.0000.0	000'	0x2000	8192	0x00	OFF
7.5	'0011.0000.0000.0	000'	0x3000	12288	0x00	OFF
10.0	'0100.0000.0000.0	000'	0x4000	16384	0x00	OFF
12.5	'0101.0000.0000.0	000'	0x5000	20480	0x00	OFF
15.0	'0110.0000.0000.0	000'	0x6000	24576	0x00	OFF
17.5	'0111.0000.0000.0	000'	0x7000	28672	0x00	OFF
20.0	'0111.1111.1111.1	000'	0x7FF8	32760	0x00	OFF
> 20.0	'0111.1111.1111.1	001'	0x7FF9	32761	0x42	OFF
>20.0 + Δ**)	'0111.1111.1111.1	001'	0x7FF9	32761	0x42	ON

\*) Status bits: X = not used, F = short circuit, Ü = overflow

\*\*\*) Δ = 0.1 mA ... 2.0 mA

## 4.2 Special Formats

The version 750-465/000-200 uses a format adapted to S5 controllers with FB 250 for digitalization of the measured value. For this version, the input current range 0 mA ... 20 mA is scaled to the numerical value range 0x1000 ... 0x5001.

Table 17: Process Image – Version 750-465/000-200

Input current 0 mA - 20 mA	Numeric value				Status Byte Hex.	LED Error AI 1, 2
	Binary Measured value	*)XFÜ	Hex.	Dec.		
< 0.0	Not possible (reverse voltage protection)					
0.0	'0001.0000.0000.0	000'	0x1000	4096	0x00	OFF
2.5	'0001.1000.0000.0	000'	0x1800	6144	0x00	OFF
5.0	'0010.0000.0000.0	000'	0x2000	8192	0x00	OFF
7.5	'0010.1000.0000.0	000'	0x2800	10240	0x00	OFF
10.0	'0011.0000.0000.0	000'	0x3000	12288	0x00	OFF
12.5	'0011.1000.0000.0	000'	0x3800	14336	0x00	OFF
15.0	'0100.0000.0000.0	000'	0x4000	16384	0x00	OFF
17.5	'0100.1000.0000.0	000'	0x4800	18432	0x00	OFF
20.0	'0101.0000.0000.0	000'	0x5000	20480	0x00	OFF
> 20.0	'0101.0000.0000.0	001'	0x5001	20481	0x42	OFF
> 20.0 + Δ**)	'0101.0000.0000.0	001'	0x5001	20481	0x42	ON

\*) Status bits: X = not used, F = short circuit, Ü = overflow

\*\* ) Δ = 0.1 mA ... 2.0 mA

## 5 Mounting

### 5.1 Mounting Sequence

Fieldbus couplers/controllers and I/O modules of the WAGO-I/O-SYSTEM 750/753 are snapped directly on a carrier rail in accordance with the European standard EN 50022 (DIN 35).

The reliable positioning and connection is made using a tongue and groove system. Due to the automatic locking, the individual devices are securely seated on the rail after installation.

Starting with the fieldbus coupler/controller, the I/O modules are mounted adjacent to each other according to the project design. Errors in the design of the node in terms of the potential groups (connection via the power contacts) are recognized, as the I/O modules with power contacts (blade contacts) cannot be linked to I/O modules with fewer power contacts.

#### CAUTION

##### **Risk of injury due to sharp-edged blade contacts!**

The blade contacts are sharp-edged. Handle the I/O module carefully to prevent injury.

#### NOTICE

##### **Insert I/O modules only from the proper direction!**

All I/O modules feature grooves for power jumper contacts on the right side. For some I/O modules, the grooves are closed on the top. Therefore, I/O modules featuring a power jumper contact on the left side cannot be snapped from the top. This mechanical coding helps to avoid configuration errors, which may destroy the I/O modules. Therefore, insert I/O modules only from the right and from the top.

#### Note



##### **Don't forget the bus end module!**

Always plug a bus end module 750-600 onto the end of the fieldbus node! You must always use a bus end module at all fieldbus nodes with WAGO-I/O-SYSTEM 750 fieldbus couplers/controllers to guarantee proper data transfer.

## 5.2 Inserting and Removing Devices

### NOTICE

**Perform work on devices only if they are de-energized!**

Working on energized devices can damage them. Therefore, turn off the power supply before working on the devices.

### 5.2.1 Inserting the I/O Module

1. Position the I/O module so that the tongue and groove joints to the fieldbus coupler/controller or to the previous or possibly subsequent I/O module are engaged.

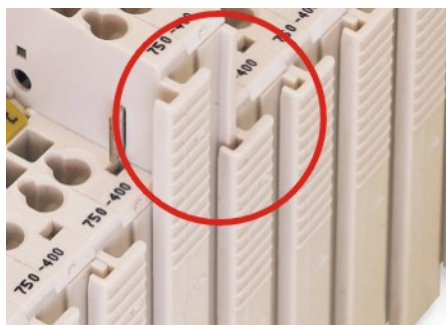

Figure 7: Insert I/O Module (Example)

2. Press the I/O module into the assembly until the I/O module snaps into the carrier rail.

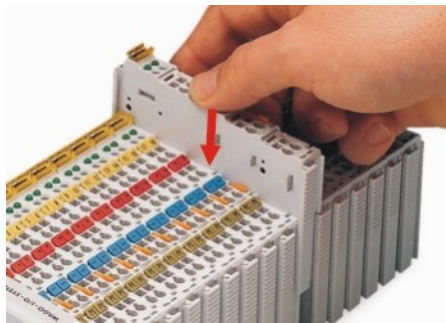

Figure 8: Snap the I/O Module into Place (Example)

With the I/O module snapped in place, the electrical connections for the data contacts and power jumper contacts (if any) to the fieldbus coupler/controller or to the previous or possibly subsequent I/O module are established.

## 5.2.2 Removing the I/O Module

1. Remove the I/O module from the assembly by pulling the release tab.

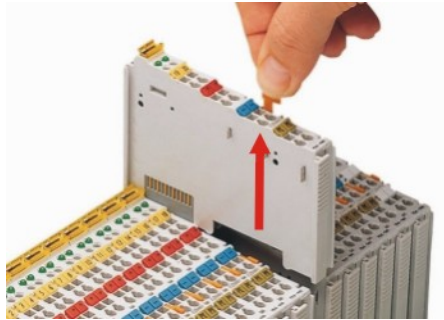

Figure 9: Removing the I/O Module (Example)

Electrical connections for data or power jumper contacts are disconnected when removing the I/O module.



## 6 Connect Devices

### 6.1 Connecting a Conductor to the CAGE CLAMP®

The WAGO CAGE CLAMP® connection is appropriate for solid, stranded and finely stranded conductors.

#### Note



**Only connect one conductor to each CAGE CLAMP®!**

Only one conductor may be connected to each CAGE CLAMP®.

Do not connect more than one conductor at one single connection!

If more than one conductor must be routed to one connection, these must be connected in an up-circuit wiring assembly, for example using WAGO feed-through terminals.

#### Exception:

If it is unavoidable to jointly connect 2 conductors, then you must use a ferrule to join the wires together. The following ferrules can be used:

Length:	8 mm
Nominal cross section <sub>max.</sub> :	1 mm <sup>2</sup> for 2 conductors with 0.5 mm <sup>2</sup> each
WAGO product:	216-103 or products with comparable properties

1. For opening the CAGE CLAMP® insert the actuating tool into the opening above the connection.
2. Insert the conductor into the corresponding connection opening.
3. For closing the CAGE CLAMP® simply remove the tool. The conductor is now clamped firmly in place.

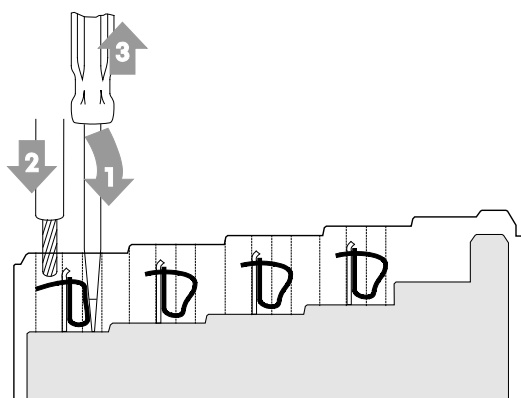

Figure 10: Connecting a Conductor to a CAGE CLAMP®

## 6.2 Connection Examples

### Note



#### Use shielded signal lines!

Only use shielded signal lines for analog signals and I/O modules which are equipped with shield clamps. Only then can you ensure that the accuracy and interference immunity specified for the respective I/O module can be achieved even in the presence of interference acting on the signal cable.

### 6.2.1 2-Wire Connection 0 V

For the 2-wire connection 0 V example, an external power supply is required for the signal conditioner.

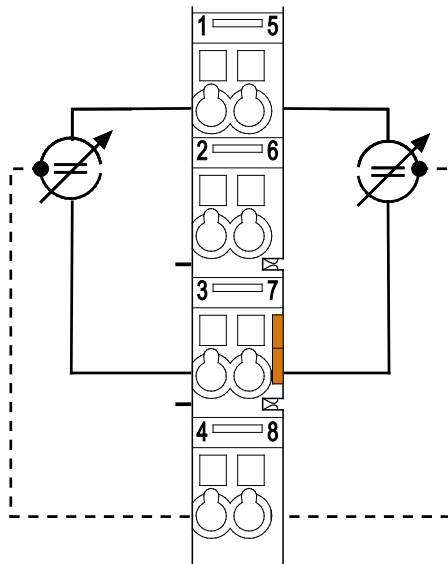

Figure 11: 2-Wire Connection 0 V

## 6.2.2 2-Wire Connection 24 V

For the 2-wire connection 24 V example, the power for the signal conditioner is supplied from the I/O module directly.

**Note**



**Field supply must be provided!**

An additional supply module must be used, which provides 24 V field supply voltage via the power jumper contacts.

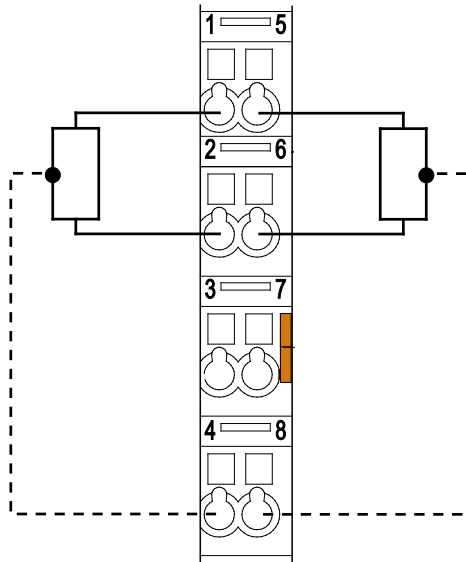

Figure 12: 2-Wire Connection 24 V

### 6.2.3 3-Wire Connection

For the 3-wire connection 24 V example, the power for the signal conditioner is supplied from the I/O module directly.

**Note****Field supply must be provided!**

An additional supply module must be used, which provides 24 V field supply voltage via the power jumper contacts.

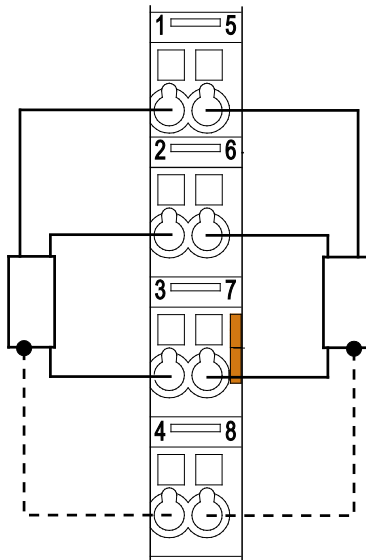

Figure 13: 3-Wire Connection 24°V

## 7 Use in Hazardous Environments

The **WAGO-I/O-SYSTEM 750** (electrical equipment) is designed for use in Zone 2 hazardous areas.

The following sections include both the general identification of components (devices) and the installation regulations to be observed. The individual subsections of the “Installation Regulations” section must be taken into account if the I/O module has the required approval or is subject to the range of application of the ATEX directive.

## 7.1 Marking Configuration Examples

### 7.1.1 Marking for Europe According to ATEX and IEC-Ex

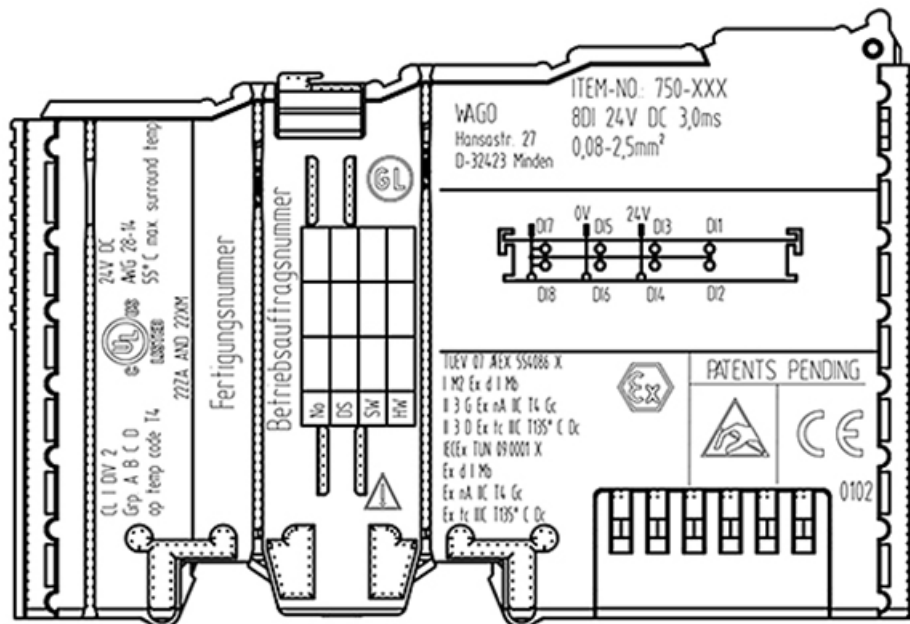

Figure 14: Side Marking Example for Approved I/O Modules According to ATEX and IECEx

TUEV 07 AEX 554086 X  
 I M2 Ex d I Mb  
 II 3 G Ex nA IIC T4 Gc  
 II 3 D Ex tc IIC T135° C Dc  
 IECEx TUN 09.0001 X  
 Ex d I Mb  
 Ex nA IIC T4 Gc  
 Ex tc IIC T135° C Dc



Figure 15: Text Detail – Marking Example for Approved I/O Modules According to ATEX and IECEx.

Table 18: Description of Marking Example for Approved I/O Modules According to ATEX and IECEx

<b>Printing on Text</b>	<b>Description</b>
TÜV 07 ATEX 554086 X IECEx TUN 09.0001 X	Approving authority and certificate numbers
<b>Dust</b>	
II	Equipment group: All except mining
3D	Category 3 (Zone 22)
Ex	Explosion protection mark
tc Dc	Type of protection and equipment protection level (EPL): protection by enclosure
IIIC	Explosion group of dust
T 135°C	Max. surface temperature of the enclosure (without a dust layer)
<b>Mining</b>	
I	Equipment group: Mining
M2	Category: High level of protection
Ex	Explosion protection mark
d Mb	Type of protection and equipment protection level (EPL): Flameproof enclosure
I	Explosion group for electrical equipment for mines susceptible to firedamp
<b>Gases</b>	
II	Equipment group: All except mining
3G	Category 3 (Zone 2)
Ex	Explosion protection mark
nA Gc	Type of protection and equipment protection level (EPL): Non-sparking equipment
nC Gc	Type of protection and equipment protection level (EPL): Sparking apparatus with protected contacts. A device which is so constructed that the external atmosphere cannot gain access to the interior
IIIC	Explosion group of gas and vapours
T4	Temperature class: Max. surface temperature 135°C

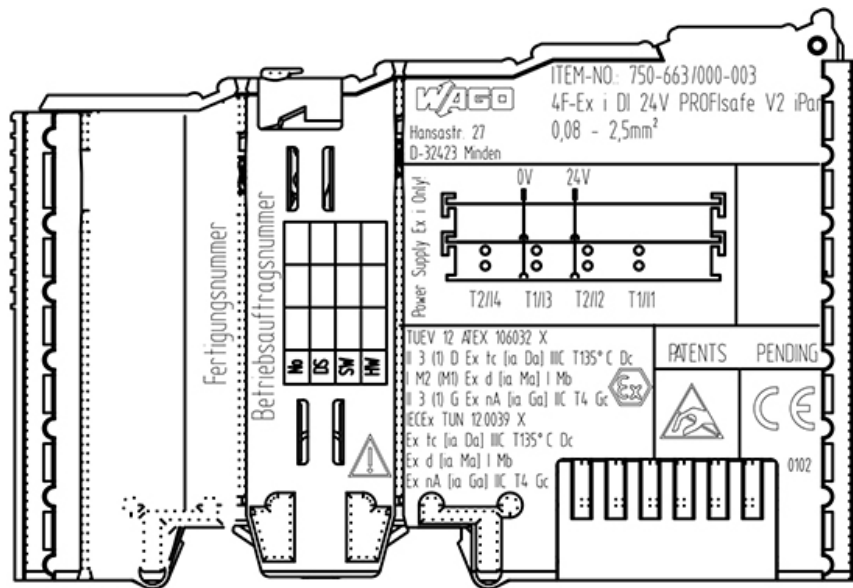

Figure 16: Side Marking Example for Approved Ex i I/O Modules According to ATEX and IECEx.

TUEV 12 ATEX 106032 X  
 II 3 (1) D Ex tc [ia Da] IIC T135° C Dc  
 I M2 (M1) Ex d [ia Ma] I Mb  
 II 3 (1) G Ex nA [ia Ga] IIC T4 Gc   
 IECEX TUN 12.0039 X  
 Ex tc [ia Da] IIC T135° C Dc  
 Ex d [ia Ma] I Mb  
 Ex nA [ia Ga] IIC T4 Gc

Figure 17: Text Detail – Marking Example for Approved Ex i I/O Modules According to ATEX and IECEx.



Table 19: Description of Marking Example for Approved Ex i I/O Modules According to ATEX and IECEx

Inscription Text	Description
TÜV 07 ATEX 554086 X IECEx TUN 09.0001X	Approving authority and certificate numbers
TÜV 12 ATEX 106032 X IECEx TUN 12.0039 X	
<b>Dust</b>	
II	Equipment group: All except mining
3(1)D	Category 3 (Zone 22) equipment containing a safety device for a category 1 (Zone 20) equipment
3(2)D	Category 3 (Zone 22) equipment containing a safety device for a category 2 (Zone 21) equipment
Ex	Explosion protection mark
tc Dc	Type of protection and equipment protection level (EPL): protection by enclosure
[ia Da]	Type of protection and equipment protection level (EPL): associated apparatus with intrinsic safety circuits for use in Zone 20
[ib Db]	Type of protection and equipment protection level (EPL): associated apparatus with intrinsic safety circuits for use in Zone 21
IIIC	Explosion group of dust
T 135°C	Max. surface temperature of the enclosure (without a dust layer)
<b>Mining</b>	
I	Equipment Group: Mining
M2 (M1)	Category: High level of protection with electrical circuits which present a very high level of protection
Ex d Mb	Explosion protection mark with Type of protection and equipment protection level (EPL): Flameproof enclosure
[ia Ma]	Type of protection and equipment protection level (EPL): associated apparatus with intrinsic safety electrical circuits
I	Explosion group for electrical equipment for mines susceptible to firedamp

Table 19: Description of Marking Example for Approved Ex i I/O Modules According to ATEX and IECEx

<b>Gases</b>	
II	Equipment group: All except mining
3(1)G	Category 3 (Zone 2) equipment containing a safety device for a category 1 (Zone 0) equipment
3(2)G	Category 3 (Zone 2) equipment containing a safety device for a category 2 (Zone 1) equipment
Ex	Explosion protection mark
nA Gc	Type of protection and equipment protection level (EPL): Non-sparking equipment
[ia Ga]	Type of protection and equipment protection level (EPL): associated apparatus with intrinsic safety circuits for use in Zone 0
[ia Gb]	Type of protection and equipment protection level (EPL): associated apparatus with intrinsic safety circuits for use in Zone 1
IIC	Explosion group of gas and vapours
T4	Temperature class: Max. surface temperature 135°C

## 7.1.2 Marking for America According to NEC 500

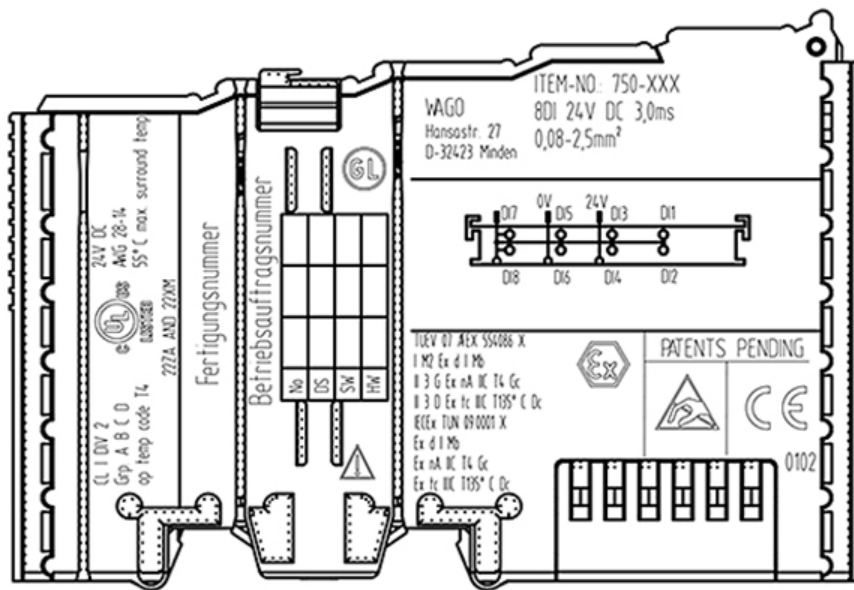

Figure 18: Side Marking Example for I/O Modules According to NEC 500

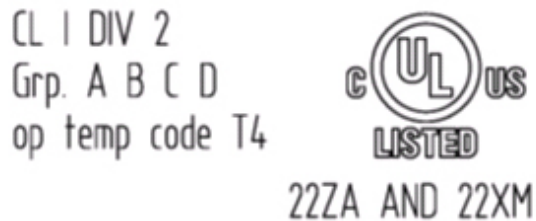

Figure 19: Text Detail – Marking Example for Approved I/O Modules According to NEC 500

Table 20: Description of Marking Example for Approved I/O Modules According to NEC 500

Printing on Text	Description
CL I	Explosion protection group (condition of use category)
DIV 2	Area of application
Grp. ABCD	Explosion group (gas group)
Op temp code T4	Temperature class

## 7.2 Installation Regulations

For the installation and operation of electrical equipment in hazardous areas, the valid national and international rules and regulations which are applicable at the installation location must be carefully followed.

## 7.2.1 Special Conditions for Safe Use (ATEX Certificate TÜV 07 ATEX 554086 X)

1. For use as Gc- or Dc-apparatus (in zone 2 or 22) the Field bus Independent I/O Modules WAGO-I/O-SYSTEM 750-\*\*\* shall be erected in an enclosure that fulfils the requirements of the applicable standards (see the marking) EN 60079-0, EN 60079-11, EN 60079-15 and EN 60079-31. For use as group I electrical apparatus M2 the apparatus shall be erected in an enclosure that ensures a sufficient protection according to EN 60079-0 and EN 60079-1 and the degree of protection IP64. The compliance of these requirements and the correct installation into an enclosure or a control cabinet of the devices shall be certified by an ExNB.
2. Measures have to be taken outside of the device that the rating voltage is not being exceeded of more than 40 % because of transient disturbances.
3. Dip-switches, binary-switches and potentiometers, connected to the module may only be actuated when explosive atmosphere can be excluded.
4. The connecting and disconnecting of the non-intrinsically safe circuits is only permitted during installation, for maintenance or for repair purposes. The temporal coincidence of explosion hazardous atmosphere and installation, maintenance resp. repair purposes shall be excluded. This is although and in particular valid for the interfaces “Memory-Card”, “USB”, “Fieldbus connection”, “Configuration and programming interface”, “antenna socket”, “D-Sub”, “DVI-port” and the “Ethernet interface”. These interfaces are not energy limited or intrinsically safe circuits. An operating of those circuits is in the behalf of the operator.
5. For the types 750-606, 750-625/000-001, 750-487/003-000, 750-484 and 750-633 the following shall be considered: The Interface circuits shall be limited to overvoltage category I/II/III (non mains/mains circuits) as defined in EN 60664-1.
6. For replaceable fuses the following shall be considered: Do not remove or replace the fuse when the apparatus is energized.
7. The following warnings shall be placed nearby the unit:  
WARNING – DO NOT REMOVE OR REPLACE FUSE WHEN ENERGIZED  
WARNING – DO NOT SEPARATE WHEN ENERGIZED  
WARNING – SEPARATE ONLY IN A NON-HAZARDOUS AREA

## 7.2.2 Special Conditions for Safe Use (ATEX Certificate TÜV 12 ATEX 106032 X)

1. For use as Gc- or Dc-apparatus (in zone 2 or 22) the Field bus Independent I/O Modules WAGO-I/O-SYSTEM 750-\*\*\* Ex i shall be erected in an enclosure that fulfils the requirements of the applicable standards (see the marking) EN 60079-0, EN 60079-11, EN 60079-15 and EN 60079-31. For use as group I electrical apparatus M2 the apparatus shall be erected in an enclosure that ensures a sufficient protection according to EN 60079-0 and EN 60079-1 and the degree of protection IP64. The compliance of these requirements and the correct installation into an enclosure or a control cabinet of the devices shall be certified by an ExNB.
2. Measures have to be taken outside of the device that the rating voltage is not being exceeded of more than 40 % because of transient disturbances.
3. The connecting and disconnecting of the non-intrinsically safe circuits is only permitted during installation, for maintenance or for repair purposes. The temporal coincidence of explosion hazardous atmosphere and installation, maintenance resp. repair purposes shall be excluded.
4. For the type the following shall be considered: The Interface circuits shall be limited to overvoltage category I/II (non mains/mains circuits) as defined in EN 60664-1.

### 7.2.3 Special Conditions for Safe Use (IEC-Ex Certificate TUN 09.0001 X)

1. For use as Gc- or Dc-apparatus (in zone 2 or 22) the Field bus Independent I/O Modules WAGO-I/O-SYSTEM 750-\*\*\* shall be erected in an enclosure that fulfils the requirements of the applicable standards (see the marking) IEC 60079-0, IEC 60079-11, IEC 60079-15 and IEC 60079-31. For use as group I electrical apparatus M2 the apparatus shall be erected in an enclosure that ensures a sufficient protection according to IEC 60079-0 and IEC 60079-1 and the degree of protection IP64.  
The compliance of these requirements and the correct installation into an enclosure or a control cabinet of the devices shall be certified by an ExCB.
2. Measures have to be taken outside of the device that the rating voltage is not being exceeded of more than 40 % because of transient disturbances.
3. DIP-switches, binary-switches and potentiometers, connected to the module may only be actuated when explosive atmosphere can be excluded.
4. The connecting and disconnecting of the non-intrinsically safe circuits is only permitted during installation, for maintenance or for repair purposes. The temporal coincidence of explosion hazardous atmosphere and installation, maintenance resp. repair purposes shall be excluded. This is although and in particular valid for the interfaces “Memory-Card”, “USB”, “Fieldbus connection”, “Configuration and programming interface”, “antenna socket”, “D-Sub”, “DVI-port” and the “Ethernet interface”. These interfaces are not energy limited or intrinsically safe circuits. An operating of those circuits is in the behalf of the operator.
5. For the types 750-606, 750-625/000-001, 750-487/003-000, 750-484 and 750-633 the following shall be considered: The Interface circuits shall be limited to overvoltage category I/II/III (non mains/mains circuits) as defined in IEC 60664-1.
6. For replaceable fuses the following shall be considered: Do not remove or replace the fuse when the apparatus is energized.
7. The following warnings shall be placed nearby the unit:  
WARNING – DO NOT REMOVE OR REPLACE FUSE WHEN ENERGIZED  
WARNING – DO NOT SEPARATE WHEN ENERGIZED  
WARNING – SEPARATE ONLY IN A NON-HAZARDOUS AREA

### 7.2.4 Special Conditions for Safe Use (IEC-Ex Certificate IECEx TUN 12.0039 X)

1. For use as Gc- or Dc-apparatus (in zone 2 or 22) the Field bus independent I/O Modules WAGO-I/O-SYSTEM 750-\*\*\* Ex i shall be erected in an enclosure that fulfils the requirements of the applicable standards (see the marking) IEC 60079-0, IEC 60079-11, IEC 60079-15, IEC 60079-31.  
For use as group I electrical apparatus M2 the apparatus shall be erected in an enclosure that ensures a sufficient protection according to IEC 60079-0 and IEC 60079-1 and the degree of protection IP64.  
The compliance of these requirements and the correct installation into an enclosure or a control cabinet of the devices shall be certified by an ExCB.
2. Measures have to be taken outside of the device that the rating voltage is not being exceeded of more than 40 % because of transient disturbances.
3. The connecting and disconnecting of the non-intrinsically safe circuits is only permitted during installation, for maintenance or for repair purposes.  
The temporal coincidence of explosion hazardous atmosphere and installation, maintenance resp. repair purposes shall be excluded.
4. For the type the following shall be considered: The Interface circuits shall be limited to overvoltage category I/II (non mains/mains circuits) as defined in IEC 60664-1.



## 7.2.5 Special Conditions for Safe Use According to ANSI/ISA 12.12.01

- A. “This equipment is suitable for use in Class I, Division 2, Groups A, B, C, D or non-hazardous locations only.”
- B. “This equipment is to be fitted within tool-secured enclosures only.”
- C. “WARNING Explosion hazard - substitution of components may impair suitability for Class I, Div. 2.”
- D. “WARNING – Do not disconnect equipment unless power has been switched off or the area is known to be non-hazardous” has to be placed near each operator accessible connector and fuse holder.
- E. When a fuse is provided, the following information shall be provided: “A switch suitable for the location where the equipment is installed shall be provided to remove the power from the fuse.”
- F. For devices with EtherCAT/Ethernet connectors “Only for use in LAN, not for connection to telecommunication circuits.”
- G. “WARNING - Use Module 750-642 only with antenna module 758-910.”
- H. For Couplers/Controllers and Economy bus modules only: The instructions shall contain the following: “The configuration interface Service connector is for temporary connection only. Do not connect or disconnect unless the area is known to be non-hazardous. Connection or disconnection in an explosive atmosphere could result in an explosion.”
- I. Modules containing fuses only: “WARNING - Devices containing fuses must not be fitted into circuits subject to over loads, e.g. motor circuits.”
- J. Modules containing SD card reader sockets only: “WARNING - Do not connect or disconnect SD-Card while circuit is live unless the area is known to be free of ignitable concentrations of flammable gases or vapors.”

---

### Information



#### **Additional Information**

Proof of certification is available on request.

Also take note of the information given on the operating and assembly instructions.

The manual, containing these special conditions for safe use, must be readily available to the user.

---

## List of Figures

Figure 1: View .....	16
Figure 2: Data Contacts .....	17
Figure 3: Power Jumper Contacts .....	18
Figure 4: CAGE CLAMP <sup>®</sup> Connectors .....	20
Figure 5: Display Elements .....	21
Figure 6: Schematic Diagram .....	22
Figure 7: Insert I/O Module (Example) .....	31
Figure 8: Snap the I/O Module into Place (Example) .....	31
Figure 9: Removing the I/O Module (Example) .....	32
Figure 10: Connecting a Conductor to a CAGE CLAMP <sup>®</sup> .....	33
Figure 11: 2-Wire Connection 0 V .....	34
Figure 12: 2-Wire Connection 24 V .....	35
Figure 13: 3-Wire Connection 24°V .....	36
Figure 14: Side Marking Example for Approved I/O Modules According to ATEX and IECEx .....	38
Figure 15: Text Detail – Marking Example for Approved I/O Modules According to ATEX and IECEx .....	38
Figure 16: Side Marking Example for Approved Ex i I/O Modules According to ATEX and IECEx .....	40
Figure 17: Text Detail – Marking Example for Approved Ex i I/O Modules According to ATEX and IECEx .....	40
Figure 18: Side Marking Example for I/O Modules According to NEC 500 .....	43
Figure 19: Text Detail – Marking Example for Approved I/O Modules According to NEC 500 .....	43

## List of Tables

Table 1: Versions.....	5
Table 2: Number Notation.....	9
Table 3: Font Conventions .....	9
Table 4: Legend for Figure “View” .....	16
Table 5: Legend for Figure “Power Jumper Contacts” .....	18
Table 6: Legend for Figure „CAGE CLAMP® Connectors” .....	20
Table 7: Legend for Figure “Display Elements” .....	21
Table 8: Technical Data – Device .....	23
Table 9: Technical Data – Supply .....	23
Table 10: Technical Data – Communication.....	23
Table 11: Technical Data – Inputs .....	23
Table 12: Technical Data – Field Wiring.....	24
Table 13: Technical Data – Power Jumper Contacts .....	24
Table 14: Technical Data – Data Contacts.....	24
Table 15: Technical Data – Climatic Environmental Conditions .....	24
Table 16: Process Image – Standard Module 750-465 and Versions 750-465/000-002 and 750-465/025-000 .....	28
Table 17: Process Image – Version 750-465/000-200 .....	29
Table 18: Description of Marking Example for Approved I/O Modules According to ATEX and IECEx .....	39
Table 19: Description of Marking Example for Approved Ex i I/O Modules According to ATEX and IECEx .....	41
Table 20: Description of Marking Example for Approved I/O Modules According to NEC 500.....	43

**WE!**  
**INNOVATE!**

WAGO Kontakttechnik GmbH & Co. KG  
Postfach 2880 • D-32385 Minden  
Hansastraße 27 • D-32423 Minden  
Phone: 05 71/8 87 – 0  
Fax: 05 71/8 87 – 1 69  
E-Mail: [info@wago.com](mailto:info@wago.com)  
Internet: <http://www.wago.com>

