

WAGO-I/O-SYSTEM 750

Manual



750-513(/xxx-xxx)
2DO 230V AC 2.0A/ Relay 2NO/ Potential Free
2-Channel Relay Output Module 230 VAC, 30 VDC,
Isolated Outputs; 2 Make Contacts

Version 1.2.2

© 2016 by WAGO Kontakttechnik GmbH & Co. KG
All rights reserved.

WAGO Kontakttechnik GmbH & Co. KG

Hansastraße 27
D-32423 Minden

Phone: +49 (0) 571/8 87 – 0
Fax: +49 (0) 571/8 87 – 1 69

E-Mail: info@wago.com

Web: <http://www.wago.com>

Technical Support

Phone: +49 (0) 571/8 87 – 5 55
Fax: +49 (0) 571/8 87 – 85 55

E-Mail: support@wago.com

Every conceivable measure has been taken to ensure the accuracy and completeness of this documentation. However, as errors can never be fully excluded, we always appreciate any information or suggestions for improving the documentation.

E-Mail: documentation@wago.com

We wish to point out that the software and hardware terms as well as the trademarks of companies used and/or mentioned in the present manual are generally protected by trademark or patent.

Table of Contents

1	Notes about this Documentation.....	5
1.1	Validity of this Documentation.....	5
1.2	Copyright.....	5
1.3	Symbols.....	6
1.4	Number Notation.....	8
1.5	Font Conventions.....	8
2	Important Notes	9
2.1	Legal Bases	9
2.1.1	Subject to Changes	9
2.1.2	Personnel Qualifications.....	9
2.1.3	Use of the WAGO-I/O-SYSTEM 750 in Compliance with Underlying Provisions.....	9
2.1.4	Technical Condition of Specified Devices.....	10
2.2	Safety Advice (Precautions).....	11
3	Device Description	13
3.1	View	15
3.2	Connectors.....	16
3.2.1	Data Contacts/Internal Bus.....	16
3.2.2	Power Jumper Contacts/Field Supply	17
3.2.3	CAGE CLAMP® Connectors	18
3.3	Display Elements	19
3.4	Schematic Diagram	20
3.5	Technical Data	21
3.5.1	Device Data	21
3.5.2	Power Supply.....	21
3.5.3	Communication	21
3.5.4	Outputs	21
3.5.5	Connection Type	22
3.5.6	Climatic Environmental Conditions.....	22
3.5.7	Load Limiting Value Graph of the Relay.....	23
3.6	Approvals	24
3.7	Standards and Guidelines	26
4	Process Image	27
5	Mounting.....	28
5.1	Mounting Sequence.....	28
5.2	Inserting and Removing Devices	29
5.2.1	Inserting the I/O Module	29
5.2.2	Removing the I/O Module.....	30
6	Connect Devices	31
6.1	Connecting a Conductor to the CAGE CLAMP®	31
6.2	Connection Examples.....	33
6.2.1	1-Wire Connection, Protection Class I Actuators	33
6.2.2	1-Wire Connection, Protection Class II and III Actuators	33
6.2.3	Operation of the Relays in Separate Circuits	34

6.2.4	Operation of the Relays in Series	34
6.3	Protective Circuits for Contacts of Relay Modules.....	36
7	Use in Hazardous Environments	38
7.1	Marking Configuration Examples.....	39
7.1.1	Marking for Europe According to ATEX and IEC-Ex	39
7.1.2	Marking for America According to NEC 500.....	44
7.2	Installation Regulations.....	45
7.2.1	Special Conditions for Safe Use (ATEX Certificate TÜV 07 ATEX 554086 X)	45
7.2.2	Special Conditions for Safe Use (ATEX Certificate TÜV 12 ATEX 106032 X)	46
7.2.3	Special Conditions for Safe Use (IEC-Ex Certificate TUN 09.0001 X)	47
7.2.4	Special Conditions for Safe Use (IEC-Ex Certificate IECEx TUN 12.0039 X)	48
7.2.5	Special Conditions for Safe Use According to ANSI/ISA 12.12.01 ..	49
	List of Figures	50
	List of Tables.....	51

1 Notes about this Documentation

Note



Always retain this documentation!

This documentation is part of the product. Therefore, retain the documentation during the entire service life of the product. Pass on the documentation to any subsequent user. In addition, ensure that any supplement to this documentation is included, if necessary.

1.1 Validity of this Documentation

This documentation is only applicable to the I/O module 750-513 (2DO 230V AC 2.0A/ Relay 2NO/ Potential Free) and the variants listed in the table below.

Table 1: Variants

Item Number/Variant	Designation
750-513	2DO 230V AC 2.0A/ Relay 2NO/ Potential Free
750-513/000-001	2DO 230V AC 2.0A/ Relay 2NO/ Potential Free / without power jumper contacts

Note



Documentation Validity for Variants

Unless otherwise indicated, the information given in this documentation applies to listed variants.

The I/O module 750-513 shall only be installed and operated according to the instructions in this manual and in the manual for the used fieldbus coupler/controller.

NOTICE

Consider power layout of the WAGO-I/O-SYSTEM 750!

In addition to these operating instructions, you will also need the manual for the used fieldbus coupler/controller, which can be downloaded at www.wago.com. There, you can obtain important information including information on electrical isolation, system power and supply specifications.

1.2 Copyright

This Manual, including all figures and illustrations, is copyright-protected. Any further use of this Manual by third parties that violate pertinent copyright provisions is prohibited. Reproduction, translation, electronic and phototechnical filing/archiving (e.g., photocopying) as well as any amendments require the written consent of WAGO Kontakttechnik GmbH & Co. KG, Minden, Germany. Non-observance will involve the right to assert damage claims.

1.3 Symbols

**DANGER****Personal Injury!**

Indicates a high-risk, imminently hazardous situation which, if not avoided, will result in death or serious injury.

**DANGER****Personal Injury Caused by Electric Current!**

Indicates a high-risk, imminently hazardous situation which, if not avoided, will result in death or serious injury.

**WARNING****Personal Injury!**

Indicates a moderate-risk, potentially hazardous situation which, if not avoided, could result in death or serious injury.

**CAUTION****Personal Injury!**

Indicates a low-risk, potentially hazardous situation which, if not avoided, may result in minor or moderate injury.

NOTICE**Damage to Property!**

Indicates a potentially hazardous situation which, if not avoided, may result in damage to property.

NOTICE**Damage to Property Caused by Electrostatic Discharge (ESD)!**

Indicates a potentially hazardous situation which, if not avoided, may result in damage to property.

Note**Important Note!**

Indicates a potential malfunction which, if not avoided, however, will not result in damage to property.



Information

Additional Information:

Refers to additional information which is not an integral part of this documentation (e.g., the Internet).

1.4 Number Notation

Table 2: Number Notation

Number Code	Example	Note
Decimal	100	Normal notation
Hexadecimal	0x64	C notation
Binary	'100' '0110.0100'	In quotation marks, nibble separated with dots (.)

1.5 Font Conventions

Table 3: Font Conventions

Font Type	Indicates
<i>italic</i>	Names of paths and data files are marked in italic-type. e.g.: <i>C:\Program Files\WAGO Software</i>
Menu	Menu items are marked in bold letters. e.g.: Save
>	A greater-than sign between two names means the selection of a menu item from a menu. e.g.: File > New
Input	Designation of input or optional fields are marked in bold letters, e.g.: Start of measurement range
“Value”	Input or selective values are marked in inverted commas. e.g.: Enter the value “4 mA” under Start of measurement range .
[Button]	Pushbuttons in dialog boxes are marked with bold letters in square brackets. e.g.: [Input]
[Key]	Keys are marked with bold letters in square brackets. e.g.: [F5]

2 Important Notes

This section includes an overall summary of the most important safety requirements and notes that are mentioned in each individual section. To protect your health and prevent damage to devices as well, it is imperative to read and carefully follow the safety guidelines.

2.1 Legal Bases

2.1.1 Subject to Changes

WAGO Kontakttechnik GmbH & Co. KG reserves the right to provide for any alterations or modifications that serve to increase the efficiency of technical progress. WAGO Kontakttechnik GmbH & Co. KG owns all rights arising from the granting of patents or from the legal protection of utility patents. Third-party products are always mentioned without any reference to patent rights. Thus, the existence of such rights cannot be excluded.

2.1.2 Personnel Qualifications

All sequences implemented on WAGO-I/O-SYSTEM 750 devices may only be carried out by electrical specialists with sufficient knowledge in automation. The specialists must be familiar with the current norms and guidelines for the devices and automated environments.

All changes to the coupler or controller should always be carried out by qualified personnel with sufficient skills in PLC programming.

2.1.3 Use of the WAGO-I/O-SYSTEM 750 in Compliance with Underlying Provisions

Fieldbus couplers, fieldbus controllers and I/O modules found in the modular WAGO-I/O-SYSTEM 750 receive digital and analog signals from sensors and transmit them to actuators or higher-level control systems. Using programmable controllers, the signals can also be (pre-) processed.

The devices have been developed for use in an environment that meets the IP20 protection class criteria. Protection against finger injury and solid impurities up to 12.5 mm diameter is assured; protection against water damage is not ensured. Unless otherwise specified, operation of the devices in wet and dusty environments is prohibited.

Operating the WAGO-I/O-SYSTEM 750 devices in home applications without further measures is only permitted if they meet the emission limits (emissions of interference) according to EN 61000-6-3. You will find the relevant information in the section “Device Description” > “Standards and Guidelines” in the manual for the used fieldbus coupler/controller.

Appropriate housing (per 2014/34/EU) is required when operating the WAGO-I/O-SYSTEM 750 in hazardous environments. Please note that a prototype test certificate must be obtained that confirms the correct installation of the system in a housing or switch cabinet.

2.1.4 Technical Condition of Specified Devices

The devices to be supplied ex works are equipped with hardware and software configurations, which meet the individual application requirements. WAGO Kontakttechnik GmbH & Co. KG will be exempted from any liability in case of changes in hardware or software as well as to non-compliant usage of devices.

Please send your request for modified and new hardware or software configurations directly to WAGO Kontakttechnik GmbH & Co. KG.

2.2 Safety Advice (Precautions)

For installing and operating purposes of the relevant device to your system the following safety precautions shall be observed:



DANGER

Do not work on devices while energized!

All power sources to the device shall be switched off prior to performing any installation, repair or maintenance work.

DANGER

Install the device only in appropriate housings, cabinets or in electrical operation rooms!

The WAGO-I/O-SYSTEM 750 and its components are an open system. As such, install the system and its components exclusively in appropriate housings, cabinets or in electrical operation rooms. Allow access to such equipment and fixtures to authorized, qualified staff only by means of specific keys or tools.



DANGER

Only connect or disconnect lines when power is safely isolated!

The lines to the device can carry hazardous voltages and currents. Contact with the lines when live can result in severe injury or death. Therefore, read and observe the following safety rules before you perform work on the device:

1. Disconnect the respective system component from the power supply.
2. Secure the system component against unintentional restart.
3. Check if the voltage is positively isolated.

NOTICE

Replace defective or damaged devices!

Replace defective or damaged device/module (e.g., in the event of deformed contacts), since the long-term functionality of device/module involved can no longer be ensured.

NOTICE**Protect the components against materials having seeping and insulating properties!**

The components are not resistant to materials having seeping and insulating properties such as: aerosols, silicones and triglycerides (found in some hand creams). If you cannot exclude that such materials will appear in the component environment, then install the components in an enclosure being resistant to the above-mentioned materials. Clean tools and materials are imperative for handling devices/modules.

NOTICE**Clean only with permitted materials!**

Clean soiled contacts using oil-free compressed air or with ethyl alcohol and leather cloths.

NOTICE**Do not use any contact spray!**

Do not use any contact spray. The spray may impair contact area functionality in connection with contamination.

NOTICE**Do not reverse the polarity of connection lines!**

Avoid reverse polarity of data and power supply lines, as this may damage the devices involved.

NOTICE**Avoid electrostatic discharge!**

The devices are equipped with electronic components that may be destroyed by electrostatic discharge when touched. Please observe the safety precautions against electrostatic discharge per DIN EN 61340-5-1/-3. When handling the devices, please ensure that environmental factors (personnel, work space and packaging) are properly grounded.

3 Device Description

The 750-513 Digital Output Module transmits binary control signals from the automation device to the connected actuators (e.g., solenoid valves, contactors, transmitters, relays or other electrical loads).

The I/O module has 2 output channels, providing for direct connection of actuators equipment with protection classes II and III.

The actuators can be wired directly to the CAGE CLAMP[®] connectors DO 1 and to an external N potential or DO2 and an external N potential. An external potential of 230 VAC or 30 VDC can be applied to relay contacts 13 and 23.

The assignment of the connections is described in the “Connectors” section. Connection examples are shown in section “Connecting Devices” > ... > “Connection Example(s)”.

NOTICE

Limit all induced voltage!

The electronic components of the I/O module can be damaged by the induced voltage produced when inductive loads are de-activated.

An appropriate protection circuit, e.g., a recovery diode, must be installed in parallel to the load to limit this induced voltage.

The I/O module contains 2 make-contact, potential-free relays. This means that only the connecting points for the relay contacts are available at the field side so that different voltages can be applied independently to both make contacts.

The floating contacts also enable, for example, series connection of both relays, or series connection of several relays when the I/O modules are set up in blocks.

When a relay is closed, the potential applied at 13 or 23 is routed to the associated second relay contact 14 or 24.

The internal system voltage is used to trigger the relays.

The switching status of the two relays is indicated via green status LEDs. The meaning of the LEDs is described in the “Display Elements” section.

Note



Use the supply module!

The standard version of the 750-513 I/O module is equipped with an integrated power contact for relaying the ground potential, while the version 750-513/000-001 does not come equipped with a power contact. When required, use a power supply module for the field-side supply of the following I/O modules.

With consideration of the power jumper contacts, the individual modules can be arranged in any combination when configuring the fieldbus node. An arrangement in groups within the group of potentials is not necessary.

NOTICE

Do not exceed maximum current via power jumper contacts!

The maximum current to flow through the power jumper contacts is 10 A. Greater currents can damage the contacts.

When configuring your system, ensure that this current is not exceeded. If exceeded, insert an additional supply module.

The I/O module 750-513 can be used with all fieldbus couplers/controllers of the WAGO-I/O-SYSTEM 750.

3.1 View

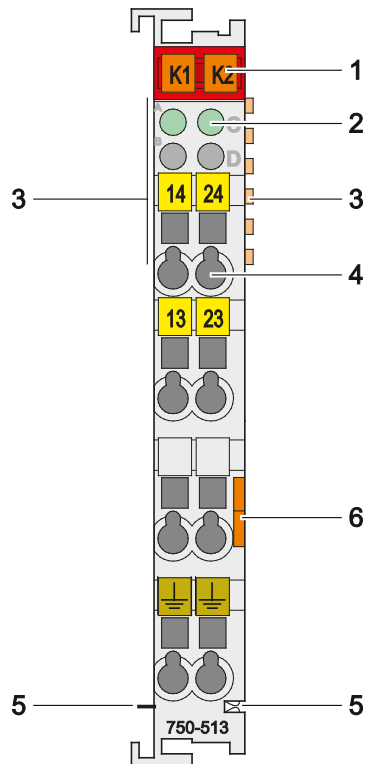

Figure 1: View

Table 4: Legend for Figure “View”

Pos.	Description	Details See Section
1	Marking possibility with Mini-WSB	---
2	Status LEDs	“Device Description” > “Display Elements”
3	Data contacts	“Device Description” > “Connectors”
4	CAGE CLAMP [®] connectors	“Device Description” > “Connectors”
5	Power jumper contacts	“Device Description” > “Connectors”
6	Release tab	“Mounting” > “Inserting and Removing Devices”

3.2 Connectors

3.2.1 Data Contacts/Internal Bus

Communication between the fieldbus coupler/controller and the I/O modules as well as the system supply of the I/O modules is carried out via the internal bus. It is comprised of 6 data contacts, which are available as self-cleaning gold spring contacts.

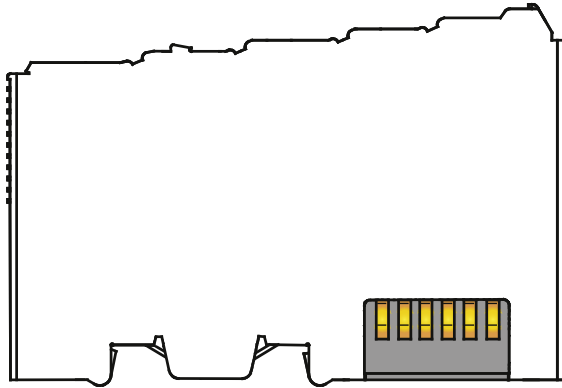

Figure 2: Data Contacts

NOTICE

Do not place the I/O modules on the gold spring contacts!

Do not place the I/O modules on the gold spring contacts in order to avoid soiling or scratching!

NOTICE



Ensure that the environment is well grounded!

The devices are equipped with electronic components that may be destroyed by electrostatic discharge. When handling the devices, ensure that the environment (persons, workplace and packing) is well grounded. Avoid touching conductive components, e.g. data contacts.

3.2.2 Power Jumper Contacts/Field Supply

Note



Use the supply module!

The standard version of the 750-513 I/O module is equipped with an integrated power contact for relaying the ground potential, while the version 750-513/000-001 does not come equipped with a power contact. When required, use a power supply module for the field-side supply of the following I/O modules.

CAUTION

Risk of injury due to sharp-edged blade contacts!

The blade contacts are sharp-edged. Handle the I/O module carefully to prevent injury.

The I/O module 750-513 has 1 self-cleaning power jumper contact that supply and transmit power for the field side. The contact on the left side of the I/O module is designed as male contact and the contact on the right side as spring contact.

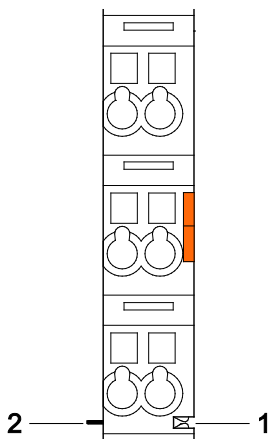

Figure 3: Power Jumper Contacts

Table 5: Legend for Figure “Power Jumper Contacts”

Contact	Type	Function
1	Spring contact	Potential transmission (Earth) for field supply
2	Blade contact	Potential feed-in (Earth) for field supply

NOTICE

Do not exceed maximum current via power jumper contacts!

The maximum current to flow through the power jumper contacts is 10 A. Greater currents can damage the contacts.

When configuring your system, ensure that this current is not exceeded. If exceeded, insert an additional supply module.

3.2.3 CAGE CLAMP® Connectors

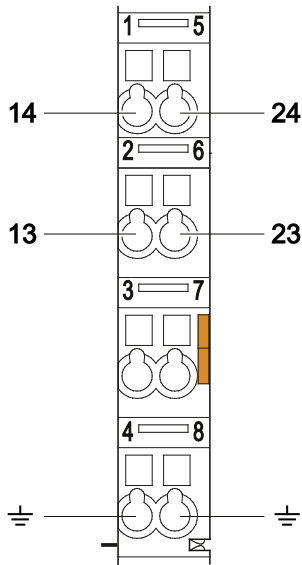

Figure 4: CAGE CLAMP® Connectors

Table 6: Legend for Figure “CAGE CLAMP® Connectors”

Channel	Designation	Connection	Function
1	14	1	Output DO 1: Make contact
	13	2	Relay contact for external potential
	Ground	4	Field supply ground
2	24	5	Output DO 2: Make contact
	23	6	Relay contact for external potential
	Ground	8	Field supply ground

3.3 Display Elements

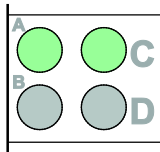

Figure 5: Display Elements

Table 7: Legend for Figure “Display Elements”

Channel	Designation	LED	State	Function
1	State relay 1	A	Off	Make contact DO1 opened
			Green	Make contact DO1 closed
2	State relay 2	C	Off	Make contact DO2 opened
			Green	Make contact DO2 closed

3.4 Schematic Diagram

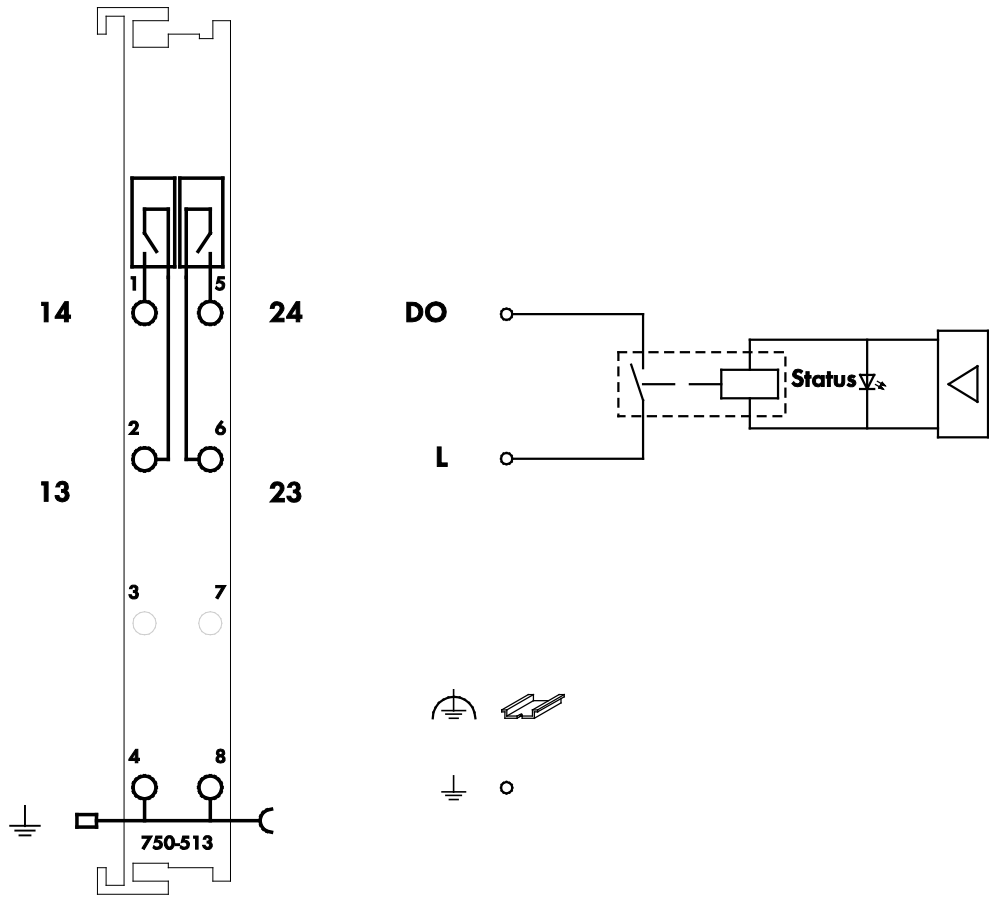

Figure 6: Schematic Diagram

3.5 Technical Data

3.5.1 Device Data

Table 8: Technical Data – Device

Width	12 mm
Height (from upper edge of 35 DIN rail)	64 mm
Depth	100 mm
Weight	Approx. 55 g

3.5.2 Power Supply

Table 9: Technical Data – Power Supply

Max. current consumption system supply (5 VDC) (internal)	100 mA
Switching voltage	250 VAC / 30 VDC
Switching power	500 VA/60 W $\cos\phi_{\max} = 0.4$; $L/R_{\max} = 7$ ms
Switching current _{min.}	10 mA / 5 VDC
Switching current _{max.}	2 A AC/DC
Isolation	1.5 kV eff. (field/system)
Rated surge voltage	2.5 kV
Overvoltage category	III

3.5.3 Communication

Table 10: Technical Data – Communication

Internal bit width	2 bits out
--------------------	------------

3.5.4 Outputs

Table 11: Technical Data – Outputs

No. of outputs	2 make contacts
Switching frequency _{max.}	30/min (at nominal load)
Pull-in time _{max.}	10 ms
Bounce time _{typ.}	1.2 ms
Drop-out time _{max.}	10 ms
Contact material	Silver alloy
Mechanical life _{max.}	2×10^7 switching operations
Electrical life _{min.}	3×10^5 (2 A / 250 VAC) or (2 A / 30 VDC)

3.5.5 Connection Type

Table 12: Technical Data – Field Wiring

Wire connection	CAGE CLAMP®
Cross section	0.08 mm ² ... 2.5 mm ² , AWG 28 ... 14
Stripped lengths	8 mm ... 9 mm / 0.33 in

Table 13: Technical Data – Power Jumper Contacts

Power jumper contacts	Blade/spring contact, self-cleaning
Voltage drop at I _{max.}	< 1 V/64 modules

Table 14: Technical Data – Data Contacts

Data contacts	Slide contact, hard gold plated, self-cleaning
---------------	--

3.5.6 Climatic Environmental Conditions

Table 15: Technical Data – Climatic Environmental Conditions

Operating temperature range	0 °C ... 55 °C
Storage temperature range	-25 °C ... +85 °C
Relative humidity without condensation	Max. 95 %
Resistance to harmful substances	Acc. to IEC 60068-2-42 and IEC 60068-2-43
Maximum pollutant concentration at relative humidity < 75 %	SO ₂ ≤ 25 ppm H ₂ S ≤ 10 ppm
Special conditions	Ensure that additional measures for components are taken, which are used in an environment involving: – dust, caustic vapors or gases – ionizing radiation

3.5.7 Load Limiting Value Graph of the Relay

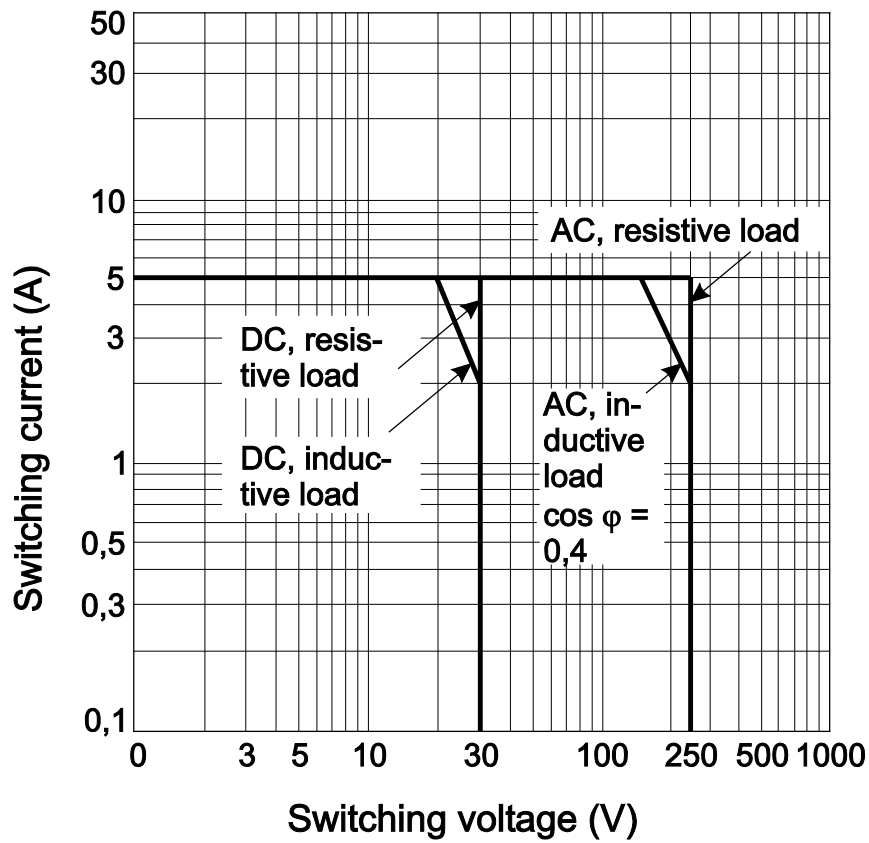

Figure 7: Load Limiting Value Graph of the Relay

3.6 Approvals

Information



More information about approvals.

Detailed references to the approvals are listed in the document “Overview Approvals **WAGO-I/O-SYSTEM 750**”, which you can find via the internet under: www.wago.com > SERVICES > DOWNLOADS > Additional documentation and information on automation products > WAGO-I/O-SYSTEM 750 > System Description.

The following approvals have been granted to the basic version and all variants of 750-513 I/O modules:

 Conformity Marking

 cUL_{US} UL508



Korea Certification

MSIP-REM-W43-DOM750

The following approvals have been granted to the basic version of 750-513 I/O modules and the variation 750-513/000-001:

TÜV 07 ATEX 554086 X



I M2 Ex d I Mb
II 3 G Ex nA nC IIC T4 Gc
II 3 D Ex tc IIIC T135°C Dc

IECEX TUN 09.0001 X

Ex d I Mb
Ex nA nC IIC T4 Gc
Ex tc IIIC T135°C Dc



cUL_{US} ANSI/ISA 12.12.01

Class I, Div2 ABCD T4

The following ship approvals have been granted to the basic version and all variants of 750-513 I/O modules listed in the table:

Table 16: Ship Approvals

										
750-513	X	X	X	X	X	X	X	X	X	X
750-513 /000-001		X	X	X	X	X	X		X	X



ABS (American Bureau of Shipping)



Federal Maritime and Hydrographic Agency



BV (Bureau Veritas)



DNV (Det Norske Veritas)

Class B



GL (Germanischer Lloyd)

Cat. A, B, C, D (EMC 1)



KR (Korean Register of Shipping)



LR (Lloyd's Register)

Env. 1, 2, 3, 4



NKK (Nippon Kaiji Kyokai)



PRS (Polski Rejestr Statków)



RINA (Registro Italiano Navale)

3.7 Standards and Guidelines

All variations of 750-513 I/O modules meet the following requirements on emission and immunity of interference:

EMC CE-Emission of interference acc. to EN 61000-6-4

EMC CE-Immunity to interference acc. to EN 61000-6-2

EMC marine applications-Emission
of interference acc. to DNV GL

EMC marine applications-Immunity
to interference acc. to DNV GL

4 Process Image

Note



Mapping of process data in the process image of fieldbus systems

The representation of the process data of some I/O modules or their variants in the process image depends on the fieldbus coupler/controller used. Please take this information from the section “Fieldbus Specific Design of the Process Data” included in the description concerning the process image of the corresponding fieldbus coupler/controller.

Table 17: Output Bits

		Bit 1	Bit 0
		DO 2	DO 1
DO 1	Signal state DO 1 – digital output channel 1		
DO 2	Signal state DO 2 – digital output channel 2		

5 Mounting

5.1 Mounting Sequence

Fieldbus couplers/controllers and I/O modules of the WAGO-I/O-SYSTEM 750/753 are snapped directly on a carrier rail in accordance with the European standard EN 50022 (DIN 35).

The reliable positioning and connection is made using a tongue and groove system. Due to the automatic locking, the individual devices are securely seated on the rail after installation.

Starting with the fieldbus coupler/controller, the I/O modules are mounted adjacent to each other according to the project design. Errors in the design of the node in terms of the potential groups (connection via the power contacts) are recognized, as the I/O modules with power contacts (blade contacts) cannot be linked to I/O modules with fewer power contacts.

CAUTION

Risk of injury due to sharp-edged blade contacts!

The blade contacts are sharp-edged. Handle the I/O module carefully to prevent injury.

NOTICE

Insert I/O modules only from the proper direction!

All I/O modules feature grooves for power jumper contacts on the right side. For some I/O modules, the grooves are closed on the top. Therefore, I/O modules featuring a power jumper contact on the left side cannot be snapped from the top. This mechanical coding helps to avoid configuration errors, which may destroy the I/O modules. Therefore, insert I/O modules only from the right and from the top.

Note



Don't forget the bus end module!

Always plug a bus end module 750-600 onto the end of the fieldbus node! You must always use a bus end module at all fieldbus nodes with WAGO-I/O-SYSTEM 750 fieldbus couplers/controllers to guarantee proper data transfer.

5.2 Inserting and Removing Devices

NOTICE

Perform work on devices only if they are de-energized!

Working on energized devices can damage them. Therefore, turn off the power supply before working on the devices.

5.2.1 Inserting the I/O Module

1. Position the I/O module so that the tongue and groove joints to the fieldbus coupler/controller or to the previous or possibly subsequent I/O module are engaged.

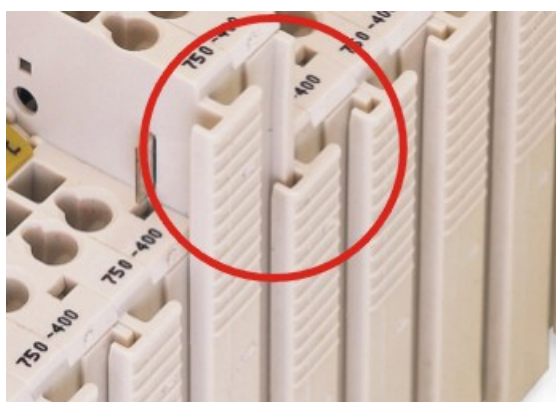

Figure 8: Insert I/O Module (Example)

2. Press the I/O module into the assembly until the I/O module snaps into the carrier rail.

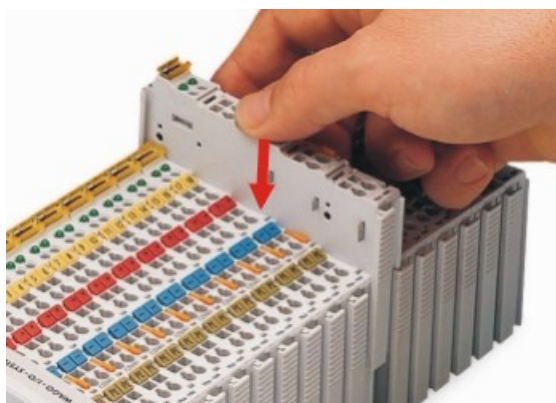

Figure 9: Snap the I/O Module into Place (Example)

With the I/O module snapped in place, the electrical connections for the data contacts and power jumper contacts (if any) to the fieldbus coupler/controller or to the previous or possibly subsequent I/O module are established.

5.2.2 Removing the I/O Module

1. Remove the I/O module from the assembly by pulling the release tab.

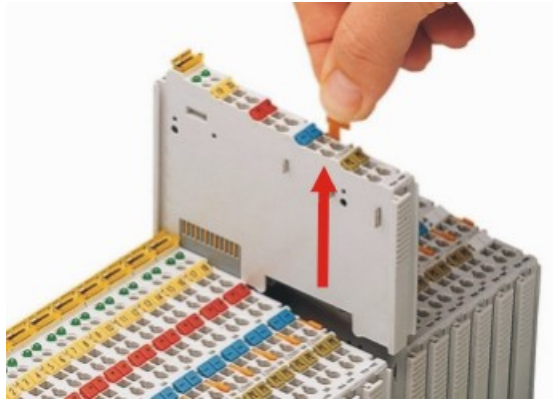

Figure 10: Removing the I/O Module (Example)

Electrical connections for data or power jumper contacts are disconnected when removing the I/O module.

6 Connect Devices



DANGER

Only connect or disconnect lines when power is safely isolated!

The lines to the device can carry hazardous voltages and currents. Contact with the lines when live can result in severe injury or death. Therefore, read and observe the following safety rules before you perform work on the device:

1. Disconnect the respective system component from the power supply.
2. Secure the system component against unintentional restart.
3. Check if the voltage is positively isolated.

6.1 Connecting a Conductor to the CAGE CLAMP®

The WAGO CAGE CLAMP® connection is appropriate for solid, stranded and finely stranded conductors.



Note

Only connect one conductor to each CAGE CLAMP®!

Only one conductor may be connected to each CAGE CLAMP®.

Do not connect more than one conductor at one single connection!

If more than one conductor must be routed to one connection, these must be connected in an up-circuit wiring assembly, for example using WAGO feed-through terminals.

1. For opening the CAGE CLAMP® insert the actuating tool into the opening above the connection.
2. Insert the conductor into the corresponding connection opening.
3. For closing the CAGE CLAMP® simply remove the tool. The conductor is now clamped firmly in place.

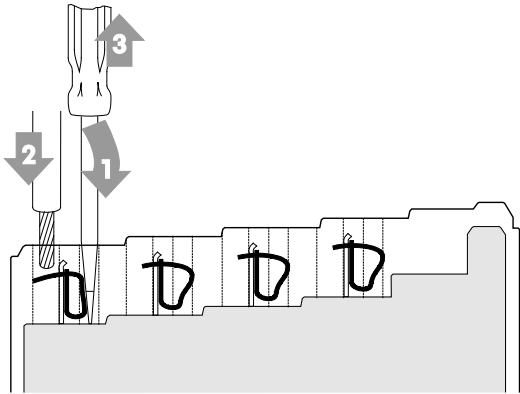

Figure 11: Connecting a Conductor to a CAGE CLAMP®

6.2 Connection Examples

6.2.1 1-Wire Connection, Protection Class I Actuators

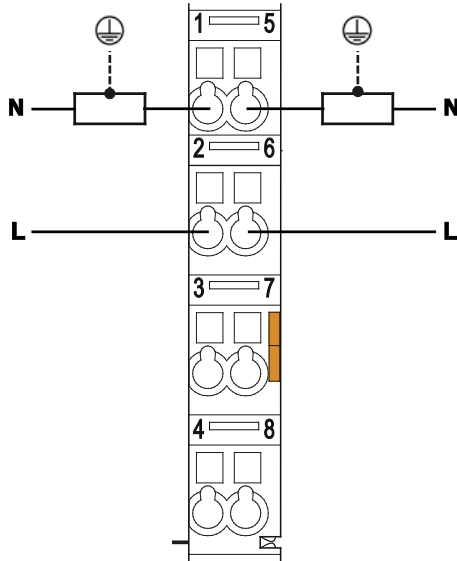

Figure 12: Connection Example, 1-Wire Connection for Protection Class I (Ground Conductor) Actuators

6.2.2 1-Wire Connection, Protection Class II and III Actuators

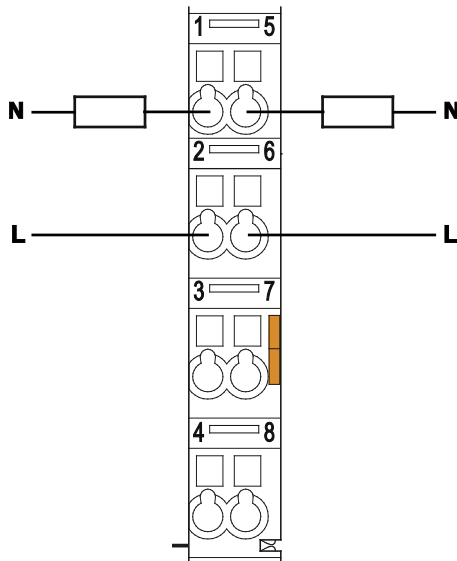

Figure 13: Connection Example 1-Wire Connection for Protection Class II (Double Insulated) and Class III (Safety Extra-Low Voltage) Actuators

6.2.3 Operation of the Relays in Separate Circuits

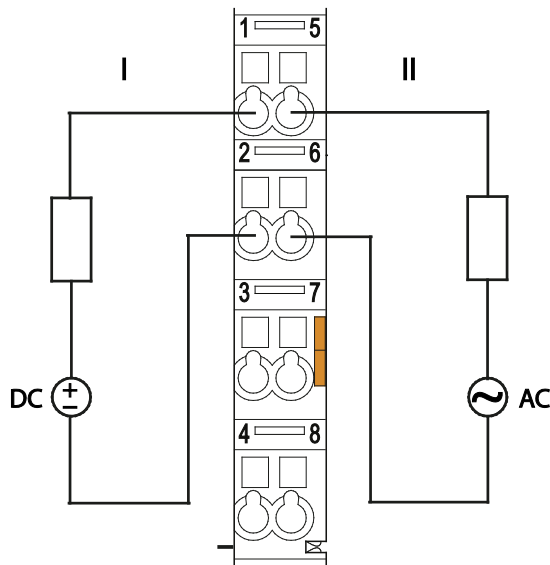

Figure 14: Connection Example – Separate Current Circuits

In this connection example, the I/O module operates in two separate current circuits. In current circuit I (DC), channel 1 acts as a make contact. In current circuit II (AC), channel 2 acts as a make contact. In this way, the following logical function is realized:

- $OUT_I = DO1$
- $OUT_II = DO2$

6.2.4 Operation of the Relays in Series

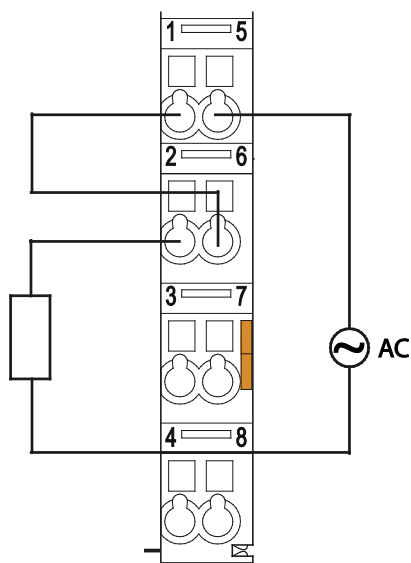

Figure 15: Connection Example – Series Connection

In this connection example, the channels of the I/O module are in series connection. Channel 1 and channel 2 act as a make contact in the circuit. In this way, the following logical function is realized:

- $OUT = DO1 \wedge DO2$

6.3 Protective Circuits for Contacts of Relay Modules

Switching off inductive loads such as contactors and solenoid valves can generate transients with voltage peaks of up to several thousand volts. Very often, these transients exceed the permissible limits specified in the EMC standards. They must therefore be limited by using external protective circuits.

Furthermore, they cause an arc, which may destroy the switching contact, and has a significant impact on the lifetime and safety of the relay. The following protective circuits, which are directly connected to the source of the interference in parallel with the consumer, have proved successful in practice:

Table 18: Protective Circuits for Contacts of Relay Modules

Protective Circuits	Additional Off-Delay	Defined Induction Voltage Limitation	Bipolar Effective Attenuation	Advantages and Disadvantages
 <p>Figure 16: Diode</p>	long	yes (U_D)	no	Advantages: <ul style="list-style-type: none"> easy implementation cost-effective and reliable uncritical dimensioning low induction voltages Disadvantages: <ul style="list-style-type: none"> attenuation only via load resistor long off-delay
 <p>Figure 17: Zener Diode and Diode</p>	medium to short	yes (U_{ZD})	no	Advantages: <ul style="list-style-type: none"> uncritical dimensioning Disadvantages: <ul style="list-style-type: none"> attenuation only above U_{ZD}
 <p>Figure 18: Suppressor Diode</p>	medium to short	yes (U_{ZD})	yes	Advantages: <ul style="list-style-type: none"> cost-effective uncritical dimensioning limitation of positive and negative peaks suitable for AC voltage Disadvantages: <ul style="list-style-type: none"> attenuation only above U_{ZD}
 <p>Figure 19: Varistor</p>	medium to short	yes (U_{VDR})	yes	Advantages: <ul style="list-style-type: none"> high power absorption uncritical dimensioning suitable for AC voltage Disadvantages: <ul style="list-style-type: none"> attenuation only above U_{VDR}

Table 18: Protective Circuits for Contacts of Relay Modules

Protective Circuits	Additional Off-Delay	Defined Induction Voltage Limitation	Bipolar Effective Attenuation	Advantages and Disadvantages
 <p>Figure 20: R/C Combination</p>	medium to short	no	yes	<p>Advantages:</p> <ul style="list-style-type: none"> • HF attenuation via power storage • suitable for AC voltage • level-independent attenuation <p>Disadvantages:</p> <ul style="list-style-type: none"> • exact dimensioning required • high inrush current

7 Use in Hazardous Environments

The **WAGO-I/O-SYSTEM 750** (electrical equipment) is designed for use in Zone 2 hazardous areas.

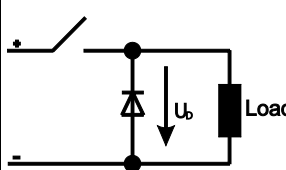
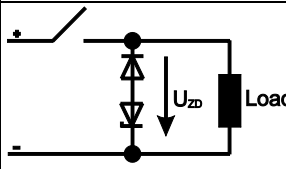
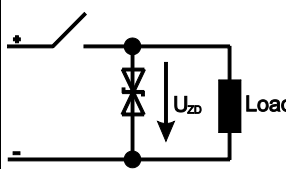
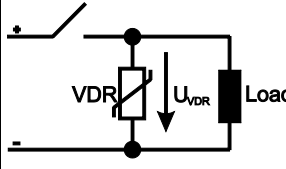
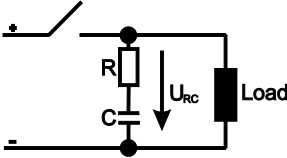
The following sections include both the general identification of components (devices) and the installation regulations to be observed. The individual subsections of the “Installation Regulations” section must be taken into account if the I/O module has the required approval or is subject to the range of application of the ATEX directive.

7.1 Marking Configuration Examples

7.1.1 Marking for Europe According to ATEX and IEC-Ex

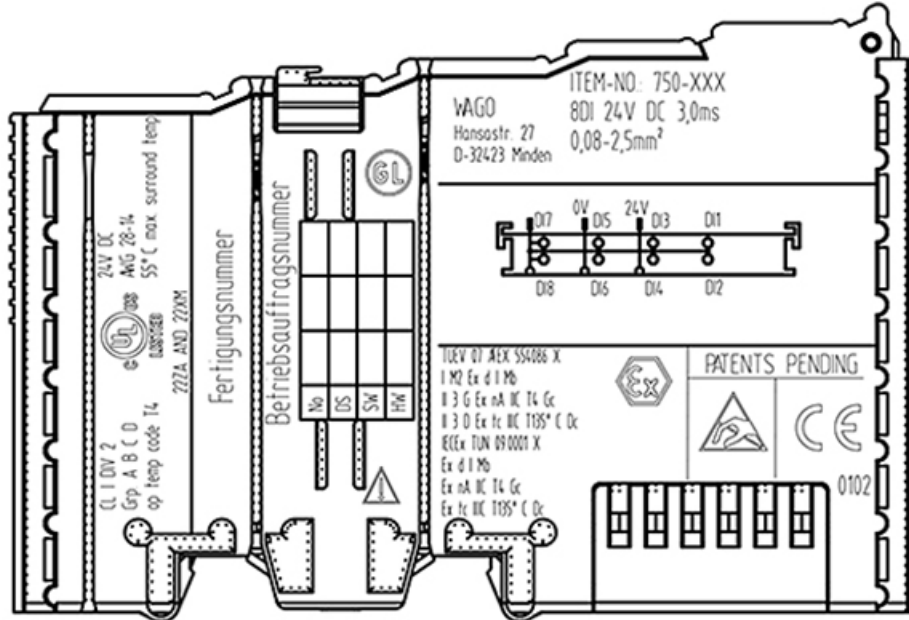

Figure 21: Side Marking Example for Approved I/O Modules According to ATEX and IECEx

TUEV 07 AEX 554086 X
I M2 Ex d I Mb
II 3 G Ex nA IIC T4 Gc
II 3 D Ex tc IIC T135° C Dc
IECEx TUN 09.0001 X
Ex d I Mb
Ex nA IIC T4 Gc
Ex tc IIC T135° C Dc



Figure 22: Text Detail – Marking Example for Approved I/O Modules According to ATEX and IECEx.

Table 19: Description of Marking Example for Approved I/O Modules According to ATEX and IECEx

Printing on Text	Description
TÜV 07 ATEX 554086 X IECEx TUN 09.0001 X	Approving authority and certificate numbers
Dust	
II	Equipment group: All except mining
3D	Category 3 (Zone 22)
Ex	Explosion protection mark
tc Dc	Type of protection and equipment protection level (EPL): protection by enclosure
IIIC	Explosion group of dust
T 135°C	Max. surface temperature of the enclosure (without a dust layer)
Mining	
I	Equipment group: Mining
M2	Category: High level of protection
Ex	Explosion protection mark
d Mb	Type of protection and equipment protection level (EPL): Flameproof enclosure
I	Explosion group for electrical equipment for mines susceptible to firedamp
Gases	
II	Equipment group: All except mining
3G	Category 3 (Zone 2)
Ex	Explosion protection mark
nA Gc	Type of protection and equipment protection level (EPL): Non-sparking equipment
nC Gc	Type of protection and equipment protection level (EPL): Sparking apparatus with protected contacts. A device which is so constructed that the external atmosphere cannot gain access to the interior
IIIC	Explosion group of gas and vapours
T4	Temperature class: Max. surface temperature 135°C

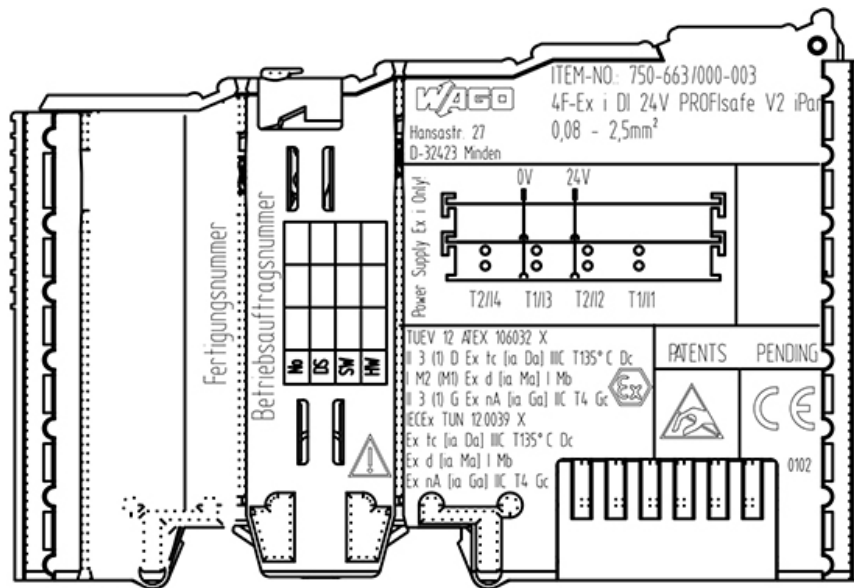

Figure 23: Side Marking Example for Approved Ex i I/O Modules According to ATEX and IECEX.

TUEV 12 ATEX 106032 X
 II 3 (1) D Ex tc [ia Da] IIC T135° C Dc
 I M2 (M1) Ex d [ia Ma] I Mb
 II 3 (1) G Ex nA [ia Ga] IIC T4 Gc 
 IECEX TUN 12.0039 X
 Ex tc [ia Da] IIC T135° C Dc
 Ex d [ia Ma] I Mb
 Ex nA [ia Ga] IIC T4 Gc

Figure 24: Text Detail – Marking Example for Approved Ex i I/O Modules According to ATEX and IECEX.

Table 20: Description of Marking Example for Approved Ex i I/O Modules According to ATEX and IECEx

Inscription Text	Description
TÜV 07 ATEX 554086 X IECEx TUN 09.0001X	Approving authority and certificate numbers
TÜV 12 ATEX 106032 X IECEx TUN 12.0039 X	
Dust	
II	Equipment group: All except mining
3(1)D	Category 3 (Zone 22) equipment containing a safety device for a category 1 (Zone 20) equipment
3(2)D	Category 3 (Zone 22) equipment containing a safety device for a category 2 (Zone 21) equipment
Ex	Explosion protection mark
tc Dc	Type of protection and equipment protection level (EPL): protection by enclosure
[ia Da]	Type of protection and equipment protection level (EPL): associated apparatus with intrinsic safety circuits for use in Zone 20
[ib Db]	Type of protection and equipment protection level (EPL): associated apparatus with intrinsic safety circuits for use in Zone 21
IIIC	Explosion group of dust
T 135°C	Max. surface temperature of the enclosure (without a dust layer)
Mining	
I	Equipment Group: Mining
M2 (M1)	Category: High level of protection with electrical circuits which present a very high level of protection
Ex d Mb	Explosion protection mark with Type of protection and equipment protection level (EPL): Flameproof enclosure
[ia Ma]	Type of protection and equipment protection level (EPL): associated apparatus with intrinsic safety electrical circuits
I	Explosion group for electrical equipment for mines susceptible to firedamp

Table 20: Description of Marking Example for Approved Ex i I/O Modules According to ATEX and IECEx

Gases	
II	Equipment group: All except mining
3(1)G	Category 3 (Zone 2) equipment containing a safety device for a category 1 (Zone 0) equipment
3(2)G	Category 3 (Zone 2) equipment containing a safety device for a category 2 (Zone 1) equipment
Ex	Explosion protection mark
nA Gc	Type of protection and equipment protection level (EPL): Non-sparking equipment
[ia Ga]	Type of protection and equipment protection level (EPL): associated apparatus with intrinsic safety circuits for use in Zone 0
[ia Gb]	Type of protection and equipment protection level (EPL): associated apparatus with intrinsic safety circuits for use in Zone 1
IIC	Explosion group of gas and vapours
T4	Temperature class: Max. surface temperature 135°C

7.1.2 Marking for America According to NEC 500

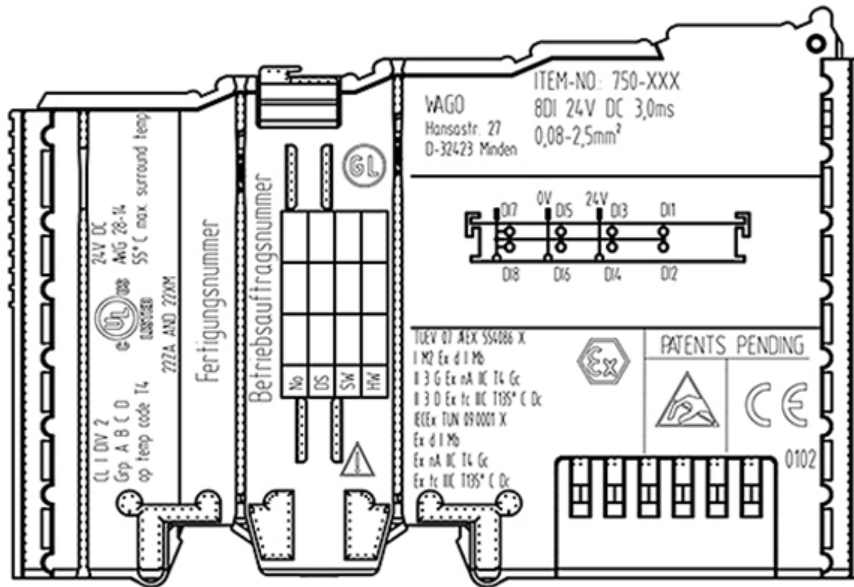

Figure 25: Side Marking Example for I/O Modules According to NEC 500

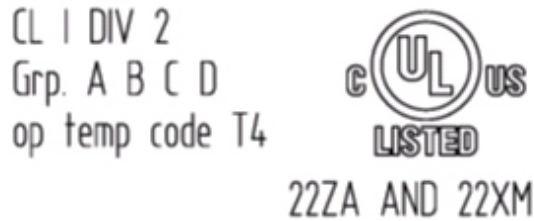

Figure 26: Text Detail – Marking Example for Approved I/O Modules According to NEC 500

Table 21: Description of Marking Example for Approved I/O Modules According to NEC 500

Printing on Text	Description
CL I	Explosion protection group (condition of use category)
DIV 2	Area of application
Grp. ABCD	Explosion group (gas group)
Op temp code T4	Temperature class

7.2 Installation Regulations

For the installation and operation of electrical equipment in hazardous areas, the valid national and international rules and regulations which are applicable at the installation location must be carefully followed.

7.2.1 Special Conditions for Safe Use (ATEX Certificate TÜV 07 ATEX 554086 X)

1. For use as Gc- or Dc-apparatus (in zone 2 or 22) the Field bus Independent I/O Modules WAGO-I/O-SYSTEM 750-*** shall be erected in an enclosure that fulfils the requirements of the applicable standards (see the marking) EN 60079-0, EN 60079-11, EN 60079-15 and EN 60079-31.
For use as group I electrical apparatus M2 the apparatus shall be erected in an enclosure that ensures a sufficient protection according to EN 60079-0 and EN 60079-1 and the degree of protection IP64.
The compliance of these requirements and the correct installation into an enclosure or a control cabinet of the devices shall be certified by an ExNB.
2. Measures have to be taken outside of the device that the rating voltage is not being exceeded of more than 40 % because of transient disturbances.
3. Dip-switches, binary-switches and potentiometers, connected to the module may only be actuated when explosive atmosphere can be excluded.
4. The connecting and disconnecting of the non-intrinsically safe circuits is only permitted during installation, for maintenance or for repair purposes. The temporal coincidence of explosion hazardous atmosphere and installation, maintenance resp. repair purposes shall be excluded.
This is although and in particular valid for the interfaces “Memory-Card”, “USB”, “Fieldbus connection”, “Configuration and programming interface”, “antenna socket”, “D-Sub”, “DVI-port” and the “Ethernet interface”. These interfaces are not energy limited or intrinsically safe circuits. An operating of those circuits is in the behalf of the operator.
5. For the types 750-606, 750-625/000-001, 750-487/003-000, 750-484 and 750-633 the following shall be considered: The Interface circuits shall be limited to overvoltage category I/II/III (non mains/mains circuits) as defined in EN 60664-1.
6. For replaceable fuses the following shall be considered: Do not remove or replace the fuse when the apparatus is energized.
7. The following warnings shall be placed nearby the unit:
WARNING – DO NOT REMOVE OR REPLACE FUSE WHEN ENERGIZED
WARNING – DO NOT SEPARATE WHEN ENERGIZED
WARNING – SEPARATE ONLY IN A NON-HAZARDOUS AREA

7.2.2 Special Conditions for Safe Use (ATEX Certificate TÜV 12 ATEX 106032 X)

1. For use as Gc- or Dc-apparatus (in zone 2 or 22) the Field bus Independent I/O Modules WAGO-I/O-SYSTEM 750-*** Ex i shall be erected in an enclosure that fulfils the requirements of the applicable standards (see the marking) EN 60079-0, EN 60079-11, EN 60079-15 and EN 60079-31. For use as group I electrical apparatus M2 the apparatus shall be erected in an enclosure that ensures a sufficient protection according to EN 60079-0 and EN 60079-1 and the degree of protection IP64. The compliance of these requirements and the correct installation into an enclosure or a control cabinet of the devices shall be certified by an ExNB.
2. Measures have to be taken outside of the device that the rating voltage is not being exceeded of more than 40 % because of transient disturbances.
3. The connecting and disconnecting of the non-intrinsically safe circuits is only permitted during installation, for maintenance or for repair purposes. The temporal coincidence of explosion hazardous atmosphere and installation, maintenance resp. repair purposes shall be excluded.
4. For the type the following shall be considered: The Interface circuits shall be limited to overvoltage category I/II (non mains/mains circuits) as defined in EN 60664-1.

7.2.3 Special Conditions for Safe Use (IEC-Ex Certificate TUN 09.0001 X)

1. For use as Gc- or Dc-apparatus (in zone 2 or 22) the Field bus Independent I/O Modules WAGO-I/O-SYSTEM 750-*** shall be erected in an enclosure that fulfils the requirements of the applicable standards (see the marking) IEC 60079-0, IEC 60079-11, IEC 60079-15 and IEC 60079-31. For use as group I electrical apparatus M2 the apparatus shall be erected in an enclosure that ensures a sufficient protection according to IEC 60079-0 and IEC 60079-1 and the degree of protection IP64. The compliance of these requirements and the correct installation into an enclosure or a control cabinet of the devices shall be certified by an ExCB.
2. Measures have to be taken outside of the device that the rating voltage is not being exceeded of more than 40 % because of transient disturbances.
3. DIP-switches, binary-switches and potentiometers, connected to the module may only be actuated when explosive atmosphere can be excluded.
4. The connecting and disconnecting of the non-intrinsically safe circuits is only permitted during installation, for maintenance or for repair purposes. The temporal coincidence of explosion hazardous atmosphere and installation, maintenance resp. repair purposes shall be excluded. This is although and in particular valid for the interfaces “Memory-Card”, “USB”, “Fieldbus connection”, “Configuration and programming interface”, “antenna socket”, “D-Sub”, “DVI-port” and the “Ethernet interface”. These interfaces are not energy limited or intrinsically safe circuits. An operating of those circuits is in the behalf of the operator.
5. For the types 750-606, 750-625/000-001, 750-487/003-000, 750-484 and 750-633 the following shall be considered: The Interface circuits shall be limited to overvoltage category I/II/III (non mains/mains circuits) as defined in IEC 60664-1.
6. For replaceable fuses the following shall be considered: Do not remove or replace the fuse when the apparatus is energized.
7. The following warnings shall be placed nearby the unit:
WARNING – DO NOT REMOVE OR REPLACE FUSE WHEN ENERGIZED
WARNING – DO NOT SEPARATE WHEN ENERGIZED
WARNING – SEPARATE ONLY IN A NON-HAZARDOUS AREA

7.2.4 Special Conditions for Safe Use (IEC-Ex Certificate IECEx TUN 12.0039 X)

1. For use as Gc- or Dc-apparatus (in zone 2 or 22) the Field bus independent I/O Modules WAGO-I/O-SYSTEM 750-*** Ex i shall be erected in an enclosure that fulfils the requirements of the applicable standards (see the marking) IEC 60079-0, IEC 60079-11, IEC 60079-15, IEC 60079-31.
For use as group I electrical apparatus M2 the apparatus shall be erected in an enclosure that ensures a sufficient protection according to IEC 60079-0 and IEC 60079-1 and the degree of protection IP64.
The compliance of these requirements and the correct installation into an enclosure or a control cabinet of the devices shall be certified by an ExCB.
2. Measures have to be taken outside of the device that the rating voltage is not being exceeded of more than 40 % because of transient disturbances.
3. The connecting and disconnecting of the non-intrinsically safe circuits is only permitted during installation, for maintenance or for repair purposes.
The temporal coincidence of explosion hazardous atmosphere and installation, maintenance resp. repair purposes shall be excluded.
4. For the type the following shall be considered: The Interface circuits shall be limited to overvoltage category I/II (non mains/mains circuits) as defined in IEC 60664-1.

7.2.5 Special Conditions for Safe Use According to ANSI/ISA 12.12.01

- A. “This equipment is suitable for use in Class I, Division 2, Groups A, B, C, D or non-hazardous locations only.”
- B. “This equipment is to be fitted within tool-secured enclosures only.”
- C. “WARNING Explosion hazard - substitution of components may impair suitability for Class I, Div. 2.”
- D. “WARNING – Do not disconnect equipment unless power has been switched off or the area is known to be non-hazardous” has to be placed near each operator accessible connector and fuse holder.
- E. When a fuse is provided, the following information shall be provided: “A switch suitable for the location where the equipment is installed shall be provided to remove the power from the fuse.”
- F. For devices with EtherCAT/Ethernet connectors “Only for use in LAN, not for connection to telecommunication circuits.”
- G. “WARNING - Use Module 750-642 only with antenna module 758-910.”
- H. For Couplers/Controllers and Economy bus modules only: The instructions shall contain the following: “The configuration interface Service connector is for temporary connection only. Do not connect or disconnect unless the area is known to be non-hazardous. Connection or disconnection in an explosive atmosphere could result in an explosion.”
- I. Modules containing fuses only: “WARNING - Devices containing fuses must not be fitted into circuits subject to over loads, e.g. motor circuits.”
- J. Modules containing SD card reader sockets only: “WARNING - Do not connect or disconnect SD-Card while circuit is live unless the area is known to be free of ignitable concentrations of flammable gases or vapors.”

Information



Additional Information

Proof of certification is available on request.

Also take note of the information given on the operating and assembly instructions.

The manual, containing these special conditions for safe use, must be readily available to the user.

List of Figures

Figure 1: View	15
Figure 2: Data Contacts	16
Figure 3: Power Jumper Contacts	17
Figure 4: CAGE CLAMP [®] Connectors	18
Figure 5: Display Elements	19
Figure 6: Schematic Diagram	20
Figure 7: Load Limiting Value Graph of the Relay	23
Figure 8: Insert I/O Module (Example)	29
Figure 9: Snap the I/O Module into Place (Example)	29
Figure 10: Removing the I/O Module (Example)	30
Figure 11: Connecting a Conductor to a CAGE CLAMP [®]	32
Figure 12: Connection Example, 1-Wire Connection for Protection Class I (Ground Conductor) Actuators	33
Figure 13: Connection Example 1-Wire Connection for Protection Class II (Double Insulated) and Class III (Safety Extra-Low Voltage) Actuators....	33
Figure 14: Connection Example – Separate Current Circuits	34
Figure 15: Connection Example – Series Connection	34
Figure 16: Diode	36
Figure 17: Zener Diode and Diode	36
Figure 18: Suppressor Diode	36
Figure 19: Varistor	36
Figure 20: R/C Combination	37
Figure 21: Side Marking Example for Approved I/O Modules According to ATEX and IECEx	39
Figure 22: Text Detail – Marking Example for Approved I/O Modules According to ATEX and IECEx	39
Figure 23: Side Marking Example for Approved Ex i I/O Modules According to ATEX and IECEx	41
Figure 24: Text Detail – Marking Example for Approved Ex i I/O Modules According to ATEX and IECEx	41
Figure 25: Side Marking Example for I/O Modules According to NEC 500	44
Figure 26: Text Detail – Marking Example for Approved I/O Modules According to NEC 500	44

List of Tables

Table 1: Variants	5
Table 2: Number Notation.....	8
Table 3: Font Conventions	8
Table 4: Legend for Figure “View”	15
Table 5: Legend for Figure “Power Jumper Contacts”	17
Table 6: Legend for Figure “CAGE CLAMP® Connectors”	18
Table 7: Legend for Figure “Display Elements”	19
Table 8: Technical Data – Device	21
Table 9: Technical Data – Power Supply	21
Table 10: Technical Data – Communication.....	21
Table 11: Technical Data – Outputs.....	21
Table 12: Technical Data – Field Wiring.....	22
Table 13: Technical Data – Power Jumper Contacts	22
Table 14: Technical Data – Data Contacts	22
Table 15: Technical Data – Climatic Environmental Conditions	22
Table 16: Ship Approvals.....	25
Table 17: Output Bits	27
Table 18: Protective Circuits for Contacts of Relay Modules.....	36
Table 19: Description of Marking Example for Approved I/O Modules According to ATEX and IECEx	40
Table 20: Description of Marking Example for Approved Ex i I/O Modules According to ATEX and IECEx	42
Table 21: Description of Marking Example for Approved I/O Modules According to NEC 500.....	44

WE! INNOVATE!

WAGO Kontakttechnik GmbH & Co. KG
Postfach 2880 • D-32385 Minden
Hansastraße 27 • D-32423 Minden
Phone: 05 71/8 87 – 0
Fax: 05 71/8 87 – 1 69
E-Mail: info@wago.com
Internet: <http://www.wago.com>

